

**20X**

**套结钉扣机（数码管 D）**

**Bar-tacking and Button Sewing Machine(LED)**

**(2019-03)**

## 前 言

欢迎您使用本公司的特种缝纫机控制系统。

请您仔细阅读本操作手册，以确保正确的操作、使用特种缝纫机，请按照本手册内注明的方式进行操作，否则，如违规操作所造成损失本公司不承担责任。此外，请将本用户手册妥善保存在安全地点，以便随时查阅。若发生故障须由本公司指定的技术人员或专业人员进行维修。

## Foreword





Thank you for using our Computerized Control System for Special Sewing Machine.

It is appreciated that you do read this manual carefully in order to operate the machine correctly and effectively. If the user operates the machine contrary to regulations herein, thus cause loss to user or third party, we will not take responsibility. Besides, you should keep this manual for future use. For any fault or problem of machine, please ask the professionals or the technicians authorized by us for repair service





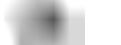

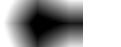



## 安全注意事项



















### 1. 安全操作的标志及含义

本使用说明书及产品所使用的安全标志是为了让您正确安全的使用产品，防止您及其他人受到伤害。标志的图案和含义如下：

	<b>危险</b> 如果忽视此标记而进行错误的操作，会导致人员的重伤或死亡。
	<b>注意</b> 如果忽视此标记而进行错误的操作，会导致人员的受伤和设备的损坏。
	该符号表示“应注意事项”。三角中的图案表示必须要注意的内容。（例如左边的图案表示：“当心受伤”）
	该符号表示“禁止”
	该符号表示“必须”。圆圈中的图案表示必须要做的内容。（例如左边的图案表示“必须接地”）

### 2. 安全注意事项





 <b>危险</b>	
	打开控制箱时，先关闭电源开关并将电源插头从插座上拔下后，等待至少 5 分钟后，再打开控制箱盖。触摸带有高电压的区域会造成人员受伤。
 <b>注意</b>	
<b>使用环境</b>	
	应避免在强电气干扰源（如高频焊机）的附近使用本缝纫机。强电气干扰源可能会影响缝纫机的正常操作。
	电源电压的波动应该在额定电压的±10%以内的环境下使用。电压大幅度的波动会影响缝纫机的正常操作，需配备稳压器。
	环境温度应在 0℃~45℃的范围内使用。低温或高温会影响缝纫机的正常操作。
	相对湿度应在 35%~85%的范围内，并且设备内不会形成结露的环境下使用。干燥、潮湿或结露的环境会影响缝纫机的正确操作。
	压缩空气的供气量应大于缝纫机所要求的总耗气量。压缩空气的供气量不足会导致缝纫机的动作不正常。
	万一发生雷电暴风雨时，关闭电源开关，并将电源插头从插座上拔下。雷电可能会影响缝纫机的正确操作。
<b>安装</b>	
	请让受过培训的技术人员来安装缝纫机。

	<p>安装完成前, 请不要连接电源。</p> <p>如果误按启动开关, 缝纫机动作会导致受伤。</p>
	<p>缝纫机头倒下或竖起时, 请用双手操作。不要用力压缝纫机。</p> <p>如缝纫机失去平衡, 缝纫机滑落到地上会造成受伤或机器损坏。</p>
	<p>必须接地。</p> <p>接驳地线不牢固, 是造成触电或误动作的原因。</p>
	<p>所有电缆应固定在离活动部件至少 25mm 以外处。另外, 不要过度弯曲或用卡钉固定得过紧。会引起火灾或触电的危险。</p>
	<p>请在机头上安装安全罩壳。</p>
<b>缝纫</b>	
	<p>本缝纫机仅限于接受过安全操作培训的人员使用。</p>
	<p>本缝纫机不能用于除缝纫外的任何用途。</p>
	<p>使用缝纫机时必须戴上保护眼镜。</p> <p>如果不戴保护眼镜, 断针时机针折断部分可能会弹入眼睛造成伤害。</p>
	<p>发生下列情况时, 请立即切断电源。否则误按下启动开关时, 会导致受伤。</p> <p>1. 机针穿线时      2. 更换机针时      3. 缝纫机不使用或人离开缝纫机时</p>
	<p>缝纫过程中, 不要触摸任何运动部件或将物件靠在运动部件上, 因为这会导致人员受伤或缝纫机损坏。</p>
	<p>如果缝纫机操作中发生误动作, 或听到异常的噪声或闻到异常的气味, 应立即切断电源。然后请与购买商店或受过培训的技术人员联系。</p>
	<p>如果缝纫机出现故障, 请与购买商店或受过培训的技术人员联系。</p>
<b>维护和检查</b>	
	<p>只有经过训练的技术人员才能进行缝纫机的维修、保养和检查。</p>
	<p>与电气有关的维修、保养和检查请及时与电控厂家的专业人员进行联系。</p>
	<p>发生下列情况时, 请关闭电源并拔下电源插头。否则误按启动开关时, 会导致受伤。</p> <p>1. 检查、调整和维修      2. 更换弯针、切刀等易损零部件</p>
	<p>在检查、调整和修理任何使用气动设备之前, 请先断开气源, 并等压力表指针下降到“0”为止。</p>
	<p>在必须接上电源开关和气源开关进行调整时, 务必十分小心遵守所有的安全注意事项。</p>
	<p>未经授权而对缝纫机进行改装而引起的缝纫机损坏不在保修范围内。</p>







## Safety Matters for Attention









### 1. Signs & Definitions of Safety Marks







This User's Manual and the Safety Marks printed on the products are to enable you to use this product correctly so as to be away from personal injury. The signs and definitions of Marks are shown in below:







 Danger	The incorrect operation due to negligence will cause the serious personal injury or even death.
 Caution	The incorrect operation due to negligence will cause the personal injury and the damage of mechanism.
	This kind of marks is "Matters for Attention", and the figure inside the triangle is the content for attention. (Exp. The left figure is "Watch Your Hand!")
	This kind of mark is "Forbidden".
	This kind of mark means "Must". The figure in the circle is the contents that have to be done. (Exp. The left figure is "Ground!")

### 2. Safety Matters for Attention

 Danger Danger	
	For opening the control box, please turn off the power and take away the plug from socket firstly, and then wait for at least 5 minutes before opening the control box. Touching the part with high voltage will cause the person injury.
 Caution Caution	
<b>Usage Environment</b>	
	Try not to use this sewing machine near the sources of strong disturbance like high-frequency welding machine. The source of strong disturbance will affect the normal operation of the sewing machine.
	The voltage fluctuation shall be within 10% of the rated voltage. The large fluctuation of voltage will affect the normal operations of sewing machine, Therefore a voltage regulator is needed in that situation.
	Working temperature: 0°C ~ 45°C. The operation of the sewing machine will be affected by environment with temperature beyond the above range.
	Relative Humidity: 35% ~ 85% (No dew inside the machine), or the operation of sewing machine will be affected.

	The supply of compressed gas shall be over the consumption required by the sewing machine. The insufficient supply of compressed gas will lead to the abnormal action of sewing machine.
	In case of thunder, lightning or storm, please turn off the power and pull plug out the socket. Because these will have influence on the operation of sewing machine.
<b>Installation</b>	
	Please ask the trained technicians to install the sewing machine.
	Don't connect machine to power supply until the installation is finished. Otherwise the action of sewing machine may cause personal injury once the start switch is pressed at that situation by mistake.
	When you tilt or erect the head of sewing machine, please use both of your hand in that operation. And never press the sewing machine with strength. If the sewing machine loses its balance, it will fall into floor thus causes the personal injury or mechanical damage.
	Grounding is a must. If the grounding cable is not fixed, it may cause the electric-shock and mis-operation of machine
	The entire cables shall be fixed with a distance at 25mm away from the moving component at least. By the way, don't excessively bend or tightly fixed the cable with nails or clamps, or it may cause the fire or electric shock.
	Please add security cover on the machine head.

<b>Sewing</b>	
	This sewing machine can only be used by the trained staff.
	This sewing machine has no other usages but the sewing.
	When operating the sewing machine, please remember to put on the glasses. Otherwise, the broken needle will cause the personal injury in case the needle is broken.
	At following circumstances, please cut off the power at once so as to avoid the personal injury caused by the mis-operation of start switch: 1.Threading on needles; 2. Replacement of needles; 3. The sewing machine is left unused or beyond supervision
	At working, don't touch or lean anything on the moving components, because both of the above behaviors will cause the personal injury or the damage of the sewing machine.
	During working, if the mis-operation happens or the abnormal noise or smell is found at the sewing machine, user shall cut off the power at once,

	and then contact the trained technicians or the supplier of that machine for solution.
	For any trouble, please contact the trained technicians or the supplier of that machine.
<b>Maintenance &amp; Inspection</b>	
	Only can the trained technicians perform the repair, maintenance and inspection of this sewing machine.
	For the repair, maintenance and inspection of the electrical component, please contact the professionals at the manufacturer of control system in time.
	At following circumstances, please cut off the power and pull off the plug at once so as to avoid the personal injury caused by the mis-operation of start switch:. 1.Repair, adjustment and inspection ; 2.Replacement of the component like curve needle, knife and so on
	Before the inspection, adjustment or repair of any gas-driven devices, user shall cut off the gas supply till the pressure indicator falls to 0.
	When adjusting the devices needing the power supply and gas supply, users can' t be too careful to follow the entire Safety Matters for Attention.
	If the sewing machine damages due to the unauthorized modification, our company will not be responsible for it.

## 目录

<b>1 概要说明</b> .....	1
1.1 20X 技术参数表 .....	1
1.2 应用机型 .....	2
1.3 输入方式 .....	2
1.4 显示方式 .....	2
1.5 面板布局 .....	2
1.6 标准化 .....	2
1.7 操作方式 .....	2
<b>2 操作及调试</b> .....	3
2.1 控制面板图示及说明 .....	3
2.2 主轴马达的安装 .....	4
2.3 调试模式 .....	5
2.3.1 CP-1 (输入信号检验) .....	7
2.3.2 CP-2 (检验 X、Y 马达/原点传感器) .....	8
2.3.3 CP-3 (连续运转) .....	10
2.3.4 CP-4 (检验主马达转速) .....	10
2.3.5 CP-7 (检验抓线马达/原点传感器) .....	13
2.4 基本操作 .....	14
2.4.1 项目数据的设定 .....	14
2.4.2 花样形状的确定 .....	16
2.4.3 缝制 .....	17
2.4.4 变更为其它花样 .....	18
2.4.5 绕线 .....	19
2.4.6 抓线装置 .....	19
2.4.7 底线计数器 .....	20
2.4.8 暂停 .....	21
2.4.9 图案线张力的设定 .....	22
2.5 设置 P 花样与 C 花样 .....	23
2.5.1 使用花样键进行缝制 .....	23
2.5.2 使用组合功能的缝制 .....	25
2.6 用户参数设置 .....	27
2.6.1 用户参数设置的具体操作 .....	27
2.6.2 用户参数设置举例 .....	28
2.6.3 用户参数设置表 .....	31
<b>3 服务参数设置</b> .....	35
3.1 服务参数的开启和变更 .....	35
3.2 服务参数列表 .....	35
3.3 恢复出厂默认设置 .....	38
3.4 软件版本显示 .....	41
3.5 查看运行总针数和清除加润滑油报警信息 .....	42

<b>4 钉扣功能</b> .....	43
4.1 钉扣功能设定 .....	43
<b>5 通过 U 盘升级花样</b> .....	44
5.1 花样升级操作 .....	44
<b>6 附录 1</b> .....	47
6.1 1900A 套结机花样一览表 .....	47
6.2 钉扣机花样一览表 .....	50
6.3 1906A 套结花样一览表 .....	51
6.4 异常信息一览表 .....	55
<b>7 附录 2</b> .....	63
7.1 电控箱安装尺寸 .....	63
7.2 操作箱安装尺寸 .....	63
7.3 控制箱外部线缆连接 .....	64
7.4 系统框图 .....	66

<b>1. General Instruction</b> .....	62
1.1 Specifications of 20X .....	62
1.2 Corresponding Machine Type.....	63
1.3 Input Mode.....	63
1.4 Display Method .....	63
1.5 Arrangement of the Panel .....	63
1.6 Standardization.....	63
1.7 Operation Mode .....	63
<b>2. Operation Instruction</b> .....	64
2.1 Instructions of the Panel .....	64
2.2 Installing the Main Motor.....	65
2.3 Test Mode.....	67
2.3.1 CP-1 (Input Signal Check).....	69
2.3.2 CP-2 (Origin Retrieval) .....	70
2.3.3 CP-3 (Continuous Operation) .....	72
2.3.4 CP-4 (Main Motor Speed Check) .....	73
2.3.5 CP-6 (Presser and Trimming Motor / Origin Sensor Check) .....	74
2.3.6 CP-7 (Thread Clamp Motor / Origin Sensor Check).....	75
2.4 Operation of the Sewing Machine (Basic) .....	76
2.4.1 Item Data Setting.....	76
2.4.2 Checking the Contour of a Sewing Pattern .....	78
2.4.3 Sewing.....	80
2.4.4 Change to Other Sewing Pattern .....	80
2.4.5 Winding a Bobbin .....	81
2.4.6 Thread Clamp Device .....	81
2.4.7 Bobbin Thread Counter .....	83
2.4.8 Temporary Stop.....	83
2.4.9 Setting the Pattern Thread Tension .....	84
2.4.10 Table of the Standard Patterns .....	85
2.5 Operations of P Pattern and C Pattern .....	89
2.5.1 Perform Sewing Using the Pattern Key.....	89
2.5.2 Perform Sewing Using the Combination Function.....	92
2.6 How to Use the Memory Switch (User Class) .....	95
2.6.1 Start and Change of the Memory Switch .....	95
2.6.2 Example of the Memory Switch Setting .....	96
2.6.3 Table of Functions of the User Class Memory Switch.....	100
<b>3. Memory Switch (Service Class)</b> .....	105
3.1 Start and Change of the Memory Switch (Service Class).....	105
3.2 Table of Functions of the Service Class Memory Switch .....	105
3.3 Restore Default Setting.....	109
3.4 Software Version Display.....	111
3.5 Check Total Number of Stitches and Clear Lubrication Alarm.....	113

<b>4. Lockstitch Button Sewing Function</b> .....	114
4.1 Lockstitch Button Sewing Function Setting .....	114
<b>5. Update the Pattern Data by USB Flash</b> .....	115
5.1 Pattern Data Update.....	115
<b>6 Appendix 1</b> .....	119
6.1 List of Patterns in 1900A Controller.....	119
6.2 List of Patterns for Button-sewing in 1900B Controller .....	122
6.3 List of Patterns for Doubling Controller .....	123
6.4 Error List .....	127
<b>7 Appendix 2</b> .....	135
7.1 Installation Size of Control Box.....	135
7.2 Installation Size of Operation Box.....	135
7.3 Diagram of Connection of the External Cable and Control Box.....	136
7.4 The Control System Diagram .....	138

# 1 概要说明

## 1.1 20X 技术参数表

No.	项 目	机 型 <b>20X</b>
1	用途	套结、钉扣
2	缝制范围	X(左右) 方向 40mm × Y(前后) 方向 30mm
3	最高缝纫速度	最高 3000rpm (双倍旋梭是 2700rpm)
4	缝迹长度	0.1mm – 10.0mm (0.1mm 单位)
5	送布	间接送布(脉冲马达 2 轴驱动方式)
6	针杆行程	41.2mm
7	机针	DP ×5 #14 (DP×5 #11(F,M), (DP×17#21 厚料))
8	抬压脚方式	脉冲马达
9	压脚上升量	标准 14mm, 最大 17mm(反转抬针时)
10	标准花样数	50 个
11	拨线方式	脉冲马达抬压脚连动
12	抓线装置	标准: 通常 0
13	面线张力	电子夹线器
14	旋梭	半旋转标准旋梭或半旋转倍旋梭
15	加油方式	旋转部: 微量加油
16	机油	缝纫机油
17	润滑脂	缝纫机用润滑脂
18	数据记忆	Flash Memory
19	放大缩小功能	X 方向、Y 方向各自独立缩放 20%~200% (1%单位)
20	放大缩小方式	线迹长度增减方式
21	缝制速度限制	400-3000rpm(100rpm 单位)
22	花样选择功能	花样号码指定方式(1-200)
23	底线记数	上转/下转方式(0 – 9999)
24	机械马达	500W 小型 AC 伺服马达(直接驱动方式)
25	外形尺寸	263mm×153mm×212mm
26	控制箱重量	约为 10 Kg
27	额定功率	600W
28	使用温度范围	0℃~45℃
29	使用湿度范围	35%~85% (无结露)
30	电源电压	AC 220V ± 10%; 50/60Hz

※最高缝制速度请根据缝制条件降低速度使用

※产品执行标准: QCYXDK0004—2016 《工业缝纫机计算机控制系统》。

## 1.2 应用机型

MSC201/MASC201 电子套结(加固)钉扣机。

## 1.3 输入方式

采用按键输入方式。

## 1.4 显示方式

采用数码管和发光二极管显示方式。

## 1.5 面板布局

操作面板整体为长方形，分为两部分，显示部分为 5 位数码管和 10 个发光二极管，操作部分为 12 个按键。参考操作说明控制面板图。

## 1.6 标准化

功能按键采用业界公认的图形标识，图形是国际化语言，各国用户都可以识别。

## 1.7 操作方式

功能键包括准备键，复位键，方式键，选择键以及抓线开关等。具体操作方法请参考第 2 节“操作说明”。

## 2 操作及调试

### 2.1 控制面板图示及说明

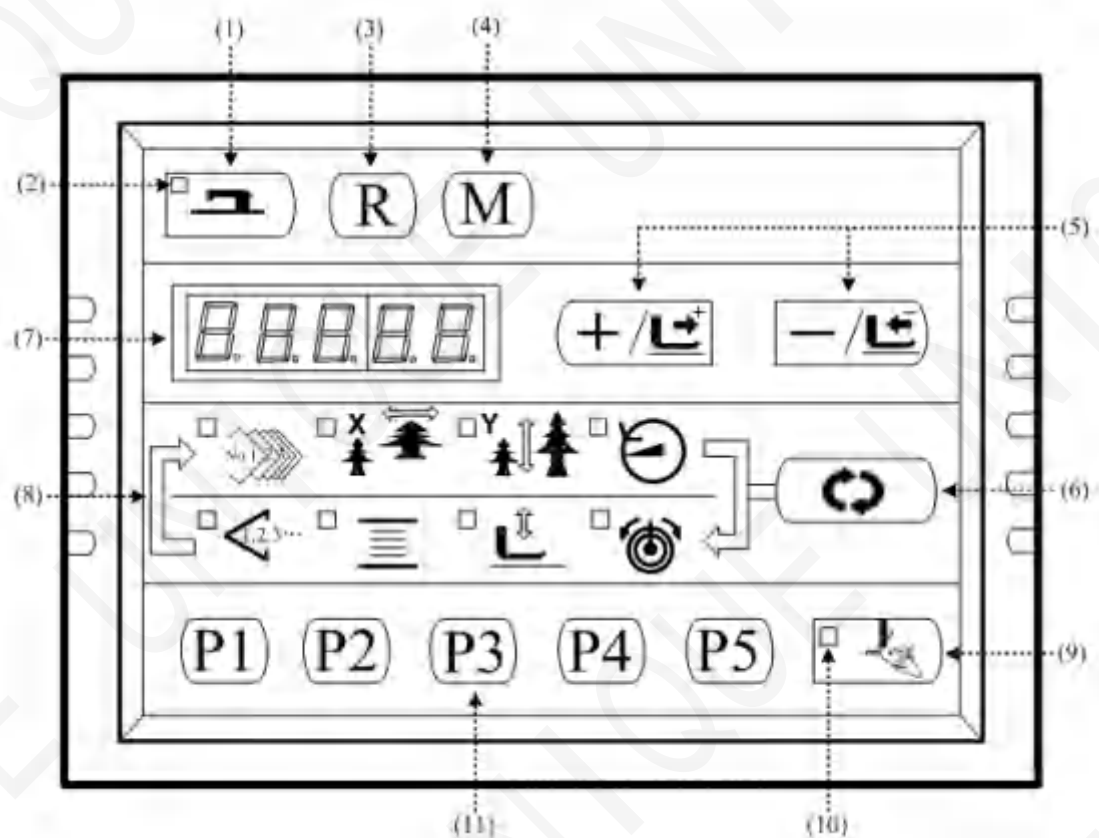

#### (1) 准备键

控制面板的设定编程状态和缝纫机实际动作的缝制状态的变换键。

#### (2) 缝制 LED

设定编程状态时为灭灯，缝制状态时为亮灯。通过准备键来切换。

#### (3) 复位键

解除异常、将设定值返回到初期值时使用。

#### (4) 方式键

设置参数或存储花样的开关键。

#### (5) +/前进传送键和-/后退传送键

适用于花样号、扩大缩小率的变更、前进/后退送布。

#### (6) 选择键

选择设定的项目。被选择项目的项目选择 LED 和设定值被显示。

#### (7) 数据显示 LED

显示花样号、扩大缩小率等被选择项目的设定值。

### (8) 项目选择 LED

被选择的项目的 LED 亮灯。



### (9) 抓线 ON/OFF 键

可以选择抓线功能的有效/无效。有效时，抓线显示 LED 亮灯。

### (10) 抓线显示 LED

LED 灯亮起时，进行抓线动作。

### (11) P 花样设置键

设置 P 花样并将其存储，存储后的 P 花样通过按此键就可立即进行缝制。

## 2.2 主轴马达的安装

主轴马达通过连接器②连接到缝纫机的上轴①上，马达连接器由 4 个螺丝分别固定到缝纫机上轴及马达主轴上。首先，将连接器第 1 螺丝⑥垂直于缝纫机上轴平面拧紧，然后拧紧连接器第 2 螺丝③；连接器第 3 螺丝⑤垂直于马达主轴平面拧紧，然后拧紧连接器第 4 螺丝④，这样完成了主轴马达与缝纫机上轴的连接。安装图示如下：

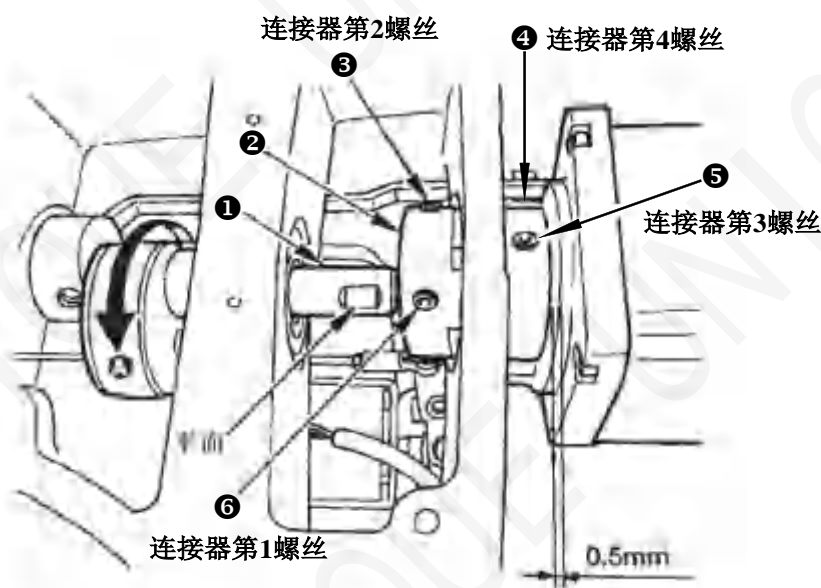

主轴马达的外部线缆朝向(从缝纫机后部向前部看去, 电机线缆朝向观察者的左手边),

安装位置如下图所示:

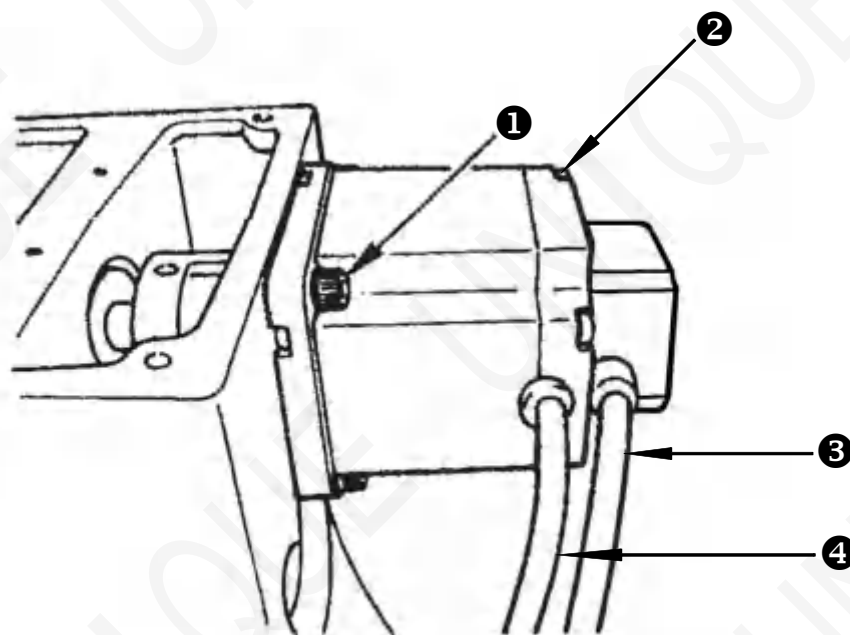



①为主轴马达安装固定螺丝, 共有 4 个; ②为主轴马达后壳固定螺丝, 共 4 个;  
③为主轴马达编码器信号线; ④为主轴马达电源线。

### 2.3 调试模式

通过启动该模式, 可进行保养检查操作。

- 1) 在缝制灯熄灭的状态下, 按 **(M)** 键, 显示 , 然后同时 **(P1)** **(P3)** **(P5)** 按下键, 听到蜂鸣器响声后, 在记忆开关的客户等级设定模式下可以进入调试模式。

(注意) 不同时按 **(P1)** **(P3)** **(P5)** 的话, 就不能进入调试模式。

- 2) 按一次  键进入调试模式, 屏幕显示“CP---”如右图所示:  ;

- 3) 按  键, 开始进行显示输出测试。显示输出测试将循环检测每个 LED 显示模块及 LED 指示灯的亮灭状态, 具体流程如下图所示:

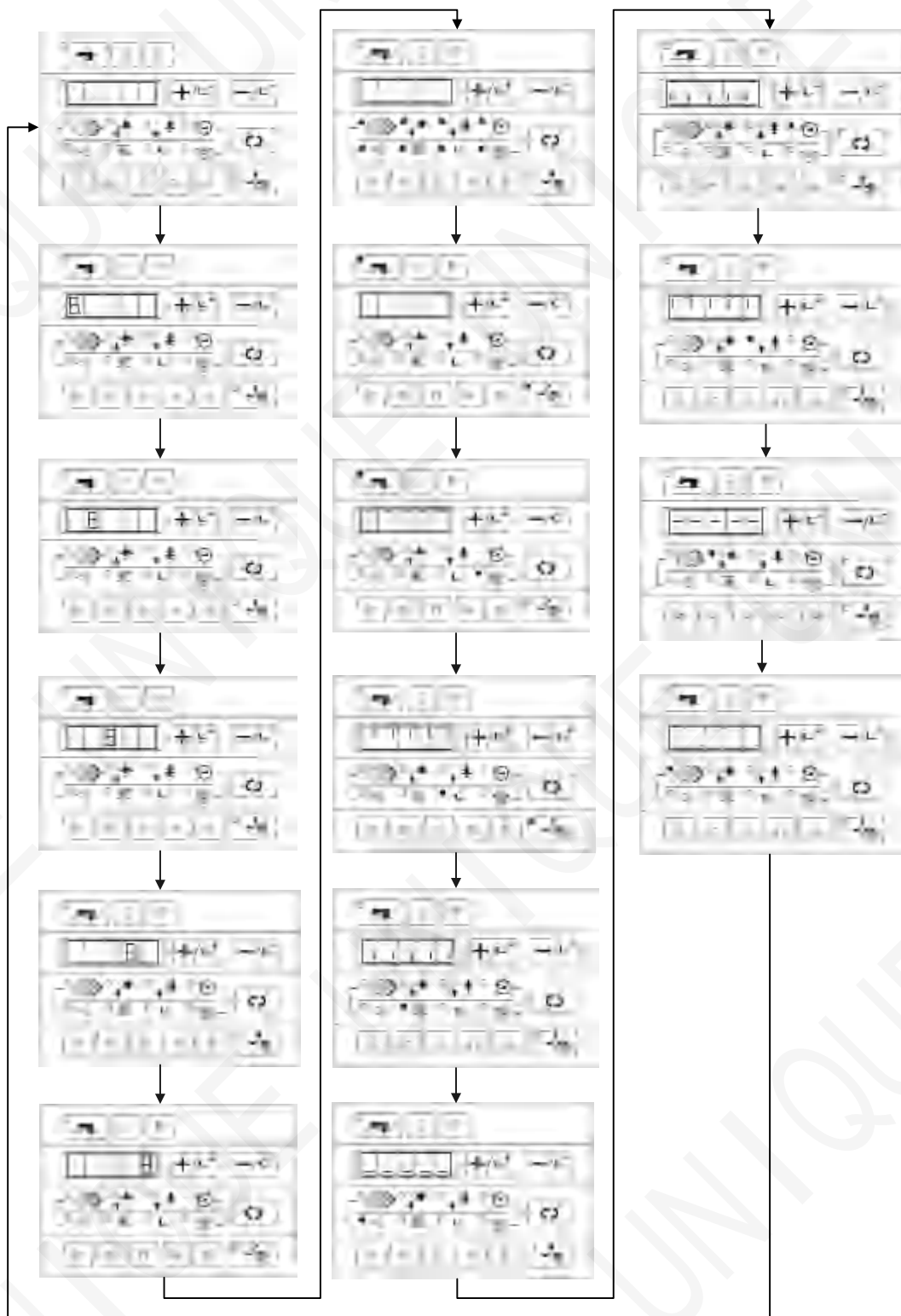

4)再次按下  键，结束显示输出测试，屏幕显示“CP-1”，如右图所示：

注：只有在显示输出测试结束之后才能进行其他功能的测试选择。

5) 按 、 键，可以变更功能测试程序号，每个序号代表的功能如下表所示：

功能测试序号	功能	内容
	输入信号检验	以灯亮提示开关, 传感器输入的状态。
	XY 马达/原点传感器检验	显示 X/Y 马达寸动操作, 原点检索操作以及 X/Y 原点传感器的状态
	连续运转	在设定连续运转条件后, 移向连续运转模式。
	主马达旋转数检验	设定旋转数、机器启动、显示实测旋转数。
	_____	_____
	压脚、切线马达/原点传感器检验	显示压脚、切线马达寸动操作, 原点检索操作, 以及压脚原点/压脚传感器的状态。
	抓线马达/原点传感器检验	显示抓线马达的寸动操作, 原点检索操作, 以及抓线原点/抓线传感器的状态。

6) 按住  键, 进入功能测试。

7) 各功能测试如果按  键的话, 就会终止测试, 返回到 5) 的状态; 但是, 如果使用过连续模式 1 次的话, 就不能解除了, 只有关闭电源才能结束。

### 2.3.1 CP-1 (输入信号检验)

能够检验造作控制盘键、踏板开关、各种传感器等的输入状态。在屏幕显示“CP-1”时,

按  键, 进入 CP-1, 屏幕显示“1”, 即第 1 项测试内容。

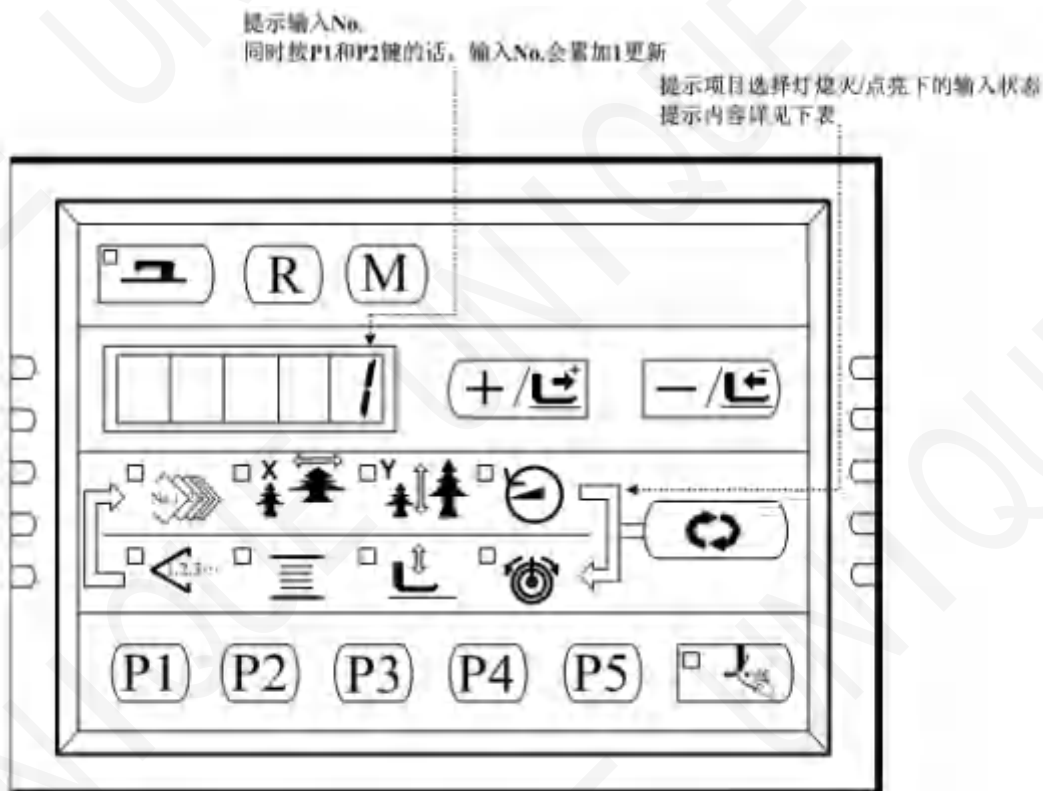



每个输入 No.的显示内容

输入 No.	花样 No. 灯	X 扩大灯	Y 扩大灯	速度灯	计数灯	套线灯	压脚下降灯	缝张力灯
1#	灯	灯	键	键	键	键	键	键
2#	灯	灯		键	键	键	键	键
3#	灯	灯						
4#	脚踏 0 档	脚踏 1 档	脚踏 2 档					
5#	压脚马达原点传感器	Y 马达原点传感器	X 马达原点传感器	抓线马达原点传感器	切线传感器	抓线传感器		
6#	主轴角度显示							
7#								
8#						机头翻起开关		

### 2.3.2 CP-2（检验 X、Y 马达/原点传感器）

显示 XY 马达的寸动操作，原点检索操作以及 X/Y 原点传感器的状态。

准备

首先按  键，进入 CP-2，屏幕显示“0”或“1”，再按  键进行抓线和切

线、压脚马达的原点检索，压脚下降，缝制灯亮起。（也可不按  键直接进行步骤 2

的操作)  
操作

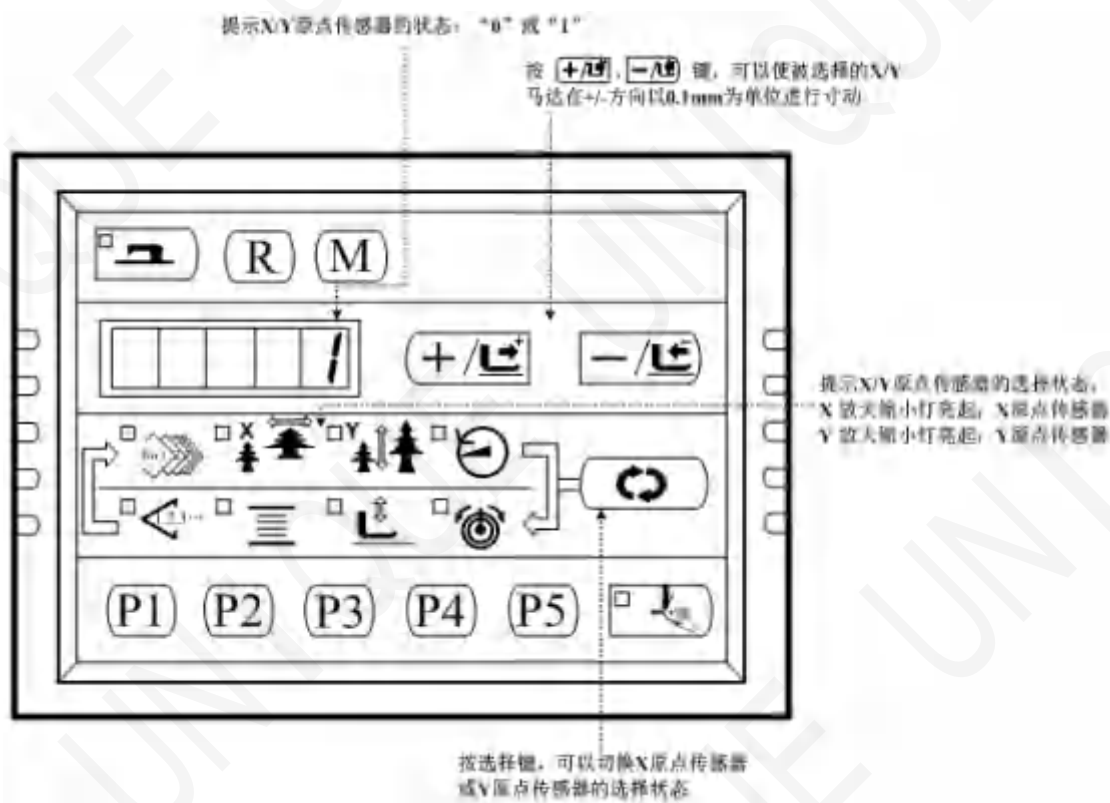

### 3. X,Y 原点微调功能







(1) 单步移动检测: 首先按 **↻** 键，进入 CP-2，屏幕显示“--”，同时 X 缩放率灯点亮。

若上电后不进入准备状态且在该界面下不按 **R** 进行原点检索，可以直接通过 **+/←**、**-/→** 键对当前选中的 X/Y 电机进行单步驱动，即在屏幕显示“--”的情况下通过 **↻** 键切换选择 X/Y 电机，选中的电机会以对应的缩放率灯点亮的形式进行提示。同时，绕线指示灯和压脚指示灯分别表示 X 电机和 Y 电机的原点光耦信号状态：点亮表示不遮光，熄灭表示遮光。

绕线灯	点亮	熄灭
X 原点光耦	不遮光	遮光

压脚灯	点亮	熄灭
Y 原点光耦	不遮光	遮光

若上电后进入过准备状态，或在该界面按下 **R** 进行原点检索，则每次进入该 CP-2 模式后，都需要先按 **R** 键进行原点检索后，才可以按方向键驱动 X/Y 马达移动，这种情况下表示对 X/Y 原点进行微调功能。

(2) X/Y 原点微调功能：在进入 CP-2 模式屏幕显示“--”的情况下，可以通过按  键进行原点检索，此时准备键灯点亮，同时屏幕显示“0.0”，X 缩放率灯点亮。其中缩放率灯表示的是当前选中的电机，而数码管中的数字表示的是原点微调值。可以通过按 、 键更改电机的原点微调值，按  键切换选择 X/Y 电机。当更改好两个电机微调值以后，按  键保存并退出。如果不想保存更改的微调值，按  键放弃保存并退出。

### 2.3.3 CP-3（连续运转）

当屏幕显示“CP-3”时，按  键，进入连续运转模式。在设定了连续运转条件后，启动连续运转模式；如果要解除连续运转模式请关闭电源。

#### 1. 间隔时间的设定

按 、 键，设定两次运转的间隔时间。

从 1800ms 至 9900ms 可以 100ms 为单位进行设定。（默认值 2000ms）设定后，按  键，保存设定值。



#### 2. 缝制结束有无原点检索的设定。

按 、 键，设定缝制结束时有无原点检索。

A0: 无效( 默认值)

A1: 有效（每次缝制结束后进行原点检索）



设定完成后，按  键，进入普通缝制模式。

#### 3. 连续操作

在普通缝制模式下，用户可以设定花样号码、X、Y 缩放率、最高转速等条件然后开始缝制。缝制结束之后，如果在第 2 步操作中设定有原点检索的话，则开始进行 X/Y 压脚、切线/抓线的各个马达的原点检索；如果在第 1 步操作中设定的休止时间后，就会自动再次

开始进行缝制；如果要中止连续缝制，请在缝纫停止时，按  键停止。

若要终止继续缝制，请关闭电源。

### 2.3.4 CP-4（检验主马达转速）







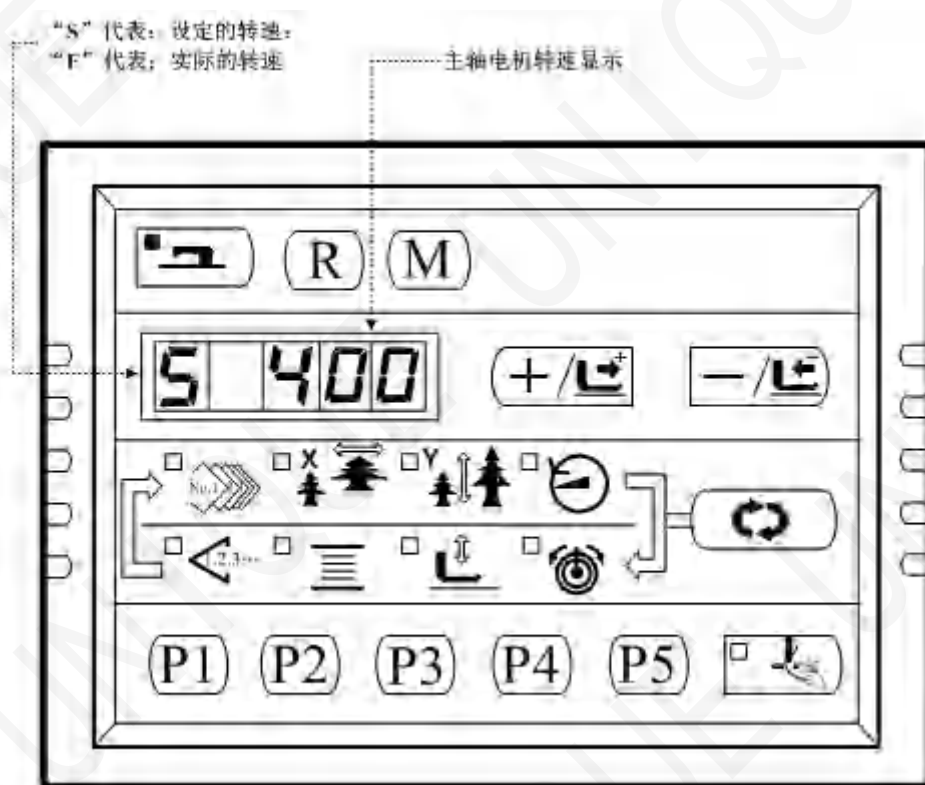



设定机器的转速，在设定的转速下仅驱动机器的主马达，显示实测的转速。

#### 1. 准备

首先按  键，进入 CP-4 自动进行抓线和压脚、切线马达的原点检索，缝制灯亮，屏幕显示“S 400”。



## 2. 操作

按 、 键，可以变更设定的主轴转速，然后按  键，机器以设定的转速开始运转。此时，按  键，可以切换设定转速显示和实际转速显示。如需再次变更设定转速，再次按  键，使用 、 键，设定转速值，然后按  键，机器以新设定的转速运转。如需停止运转，按  键。如需退出该模式，请按  键。

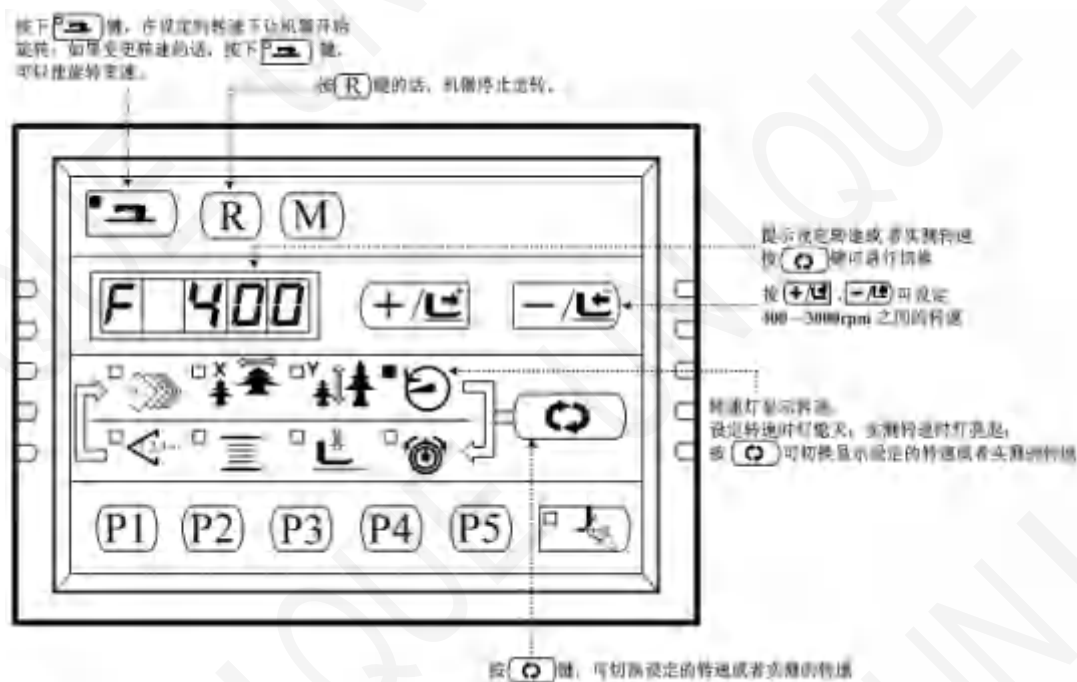

### 2.3.5 CP-6（检验压脚、切线马达/原点传感器）

显示压脚、切线马达的寸动操作，原点检索操作以及压脚原点传感器和切线传感器的状态。

准备

首先按 键，进入 CP-6 缝制灯亮，踩踏板到 2 档进行原点检索。（注：上电未进入准备状态直接进入 CP-6 模式后，可以不踩踏板进行原点检索直接按 +/- 键单步移动电机，以检测电机驱动是否正常；而一旦进入过准备状态或进行过原点检索后，则每次进入 CP-6 模式后必须先踩踏板到 2 档进行原点检索，才能按 +/- 键单步移动电机）

操作

按 键，在 6~8 次后，屏幕显示由“10”变为“11”，则切线传感器正常，如果与上述现象不符，请调整切线传感器的位置。

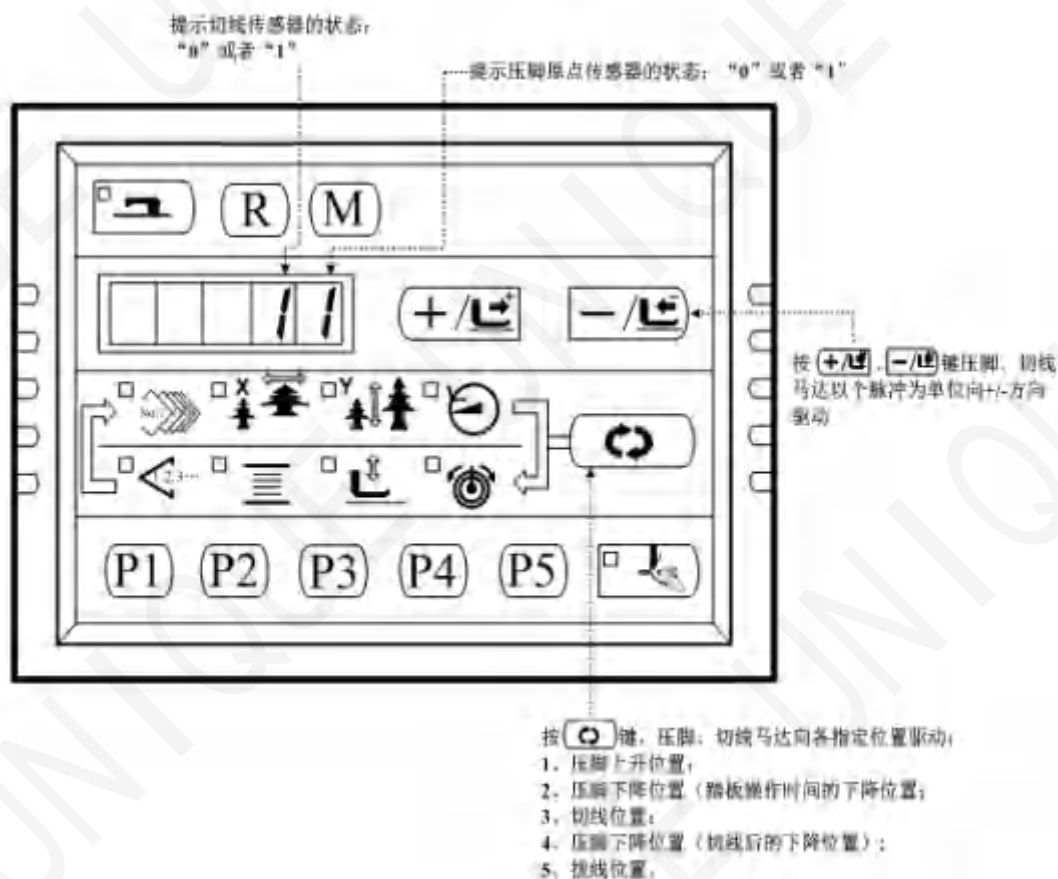

按 键, 机器上相关执行部件可以按上图所示 1~5 步, 循环动作。如需退出该模式, 请按 键退出。

### 2.3.5 CP-7 (检验抓线马达/原点传感器)

显示抓线马达的寸动操作, 原点检索操作以及抓线马达原点传感器和抓线传感器的状态。

#### 1. 准备

首先按 键, 进入 CP-7 缝制灯亮起, 踩踏板到 2 档进行原点检索。(注: 上电未进入准备状态直接进入 CP-7 模式后, 可以不踩踏板进行原点检索直接按 +/- 键单步移动电机, 以检测电机驱动是否正常; 而一旦进入过准备状态或进行过原点检索后, 则每次进入 CP-7 模式后必须先踩踏板到 2 档进行原点检索, 才能按 +/- 键单步移动电机)。

#### 2. 操作

按 、 键, 抓线器可以以脉冲为单位进行寸动。按 键, 抓线器向后驱动; 按 键, 抓线器向前驱动。

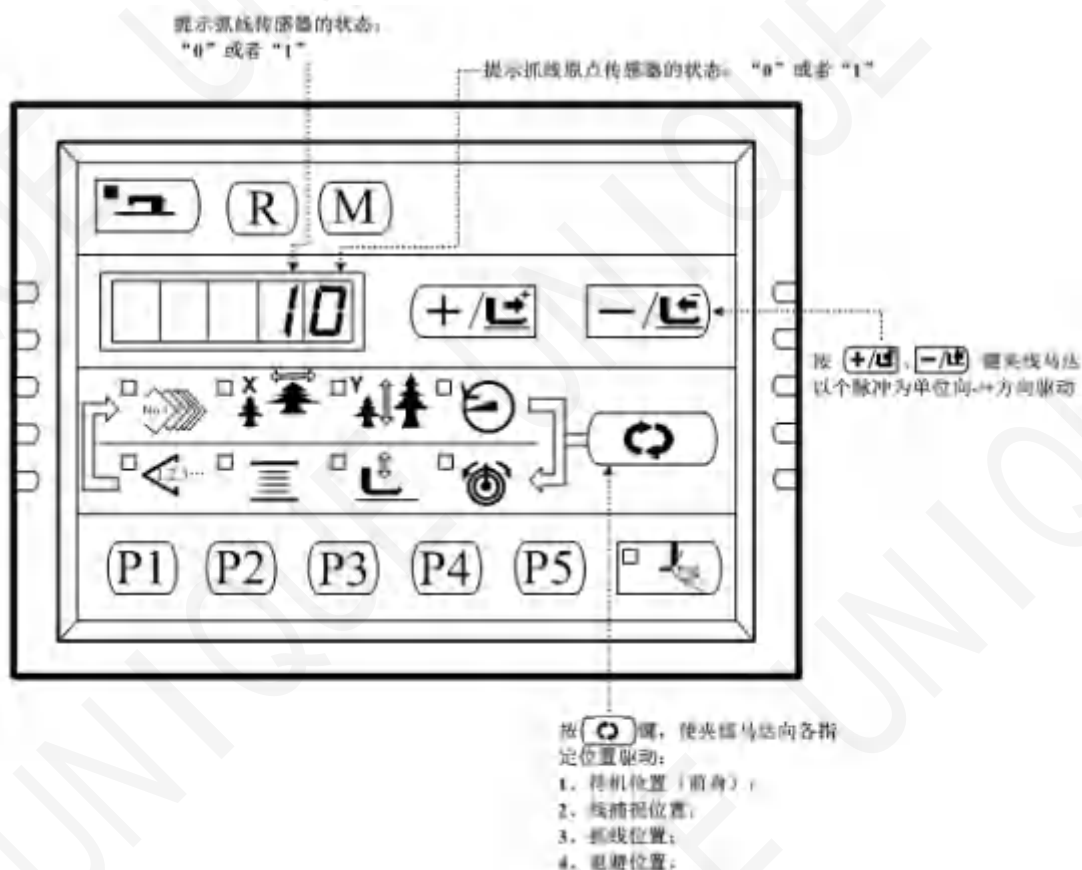

按 **↻** 键，机器可以按上图所示 1~4 的步骤循环运作。如需退出该模式，请按 **M**。

## 2.4 基本操作

### 2.4.1 项目数据的设定

请按如下的顺序设定各项目。

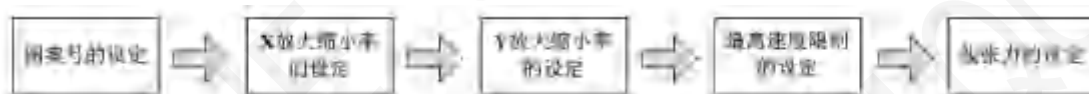

#### 1. 打开电源开关

项目选择的花样号码亮灯，数据显示部分显示出花样号码。

#### 2. 花样号码的设定

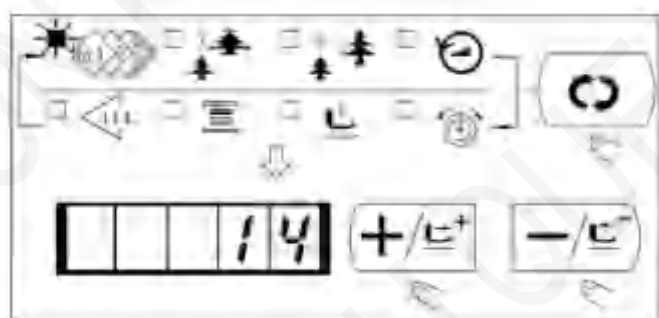





(1) 按 **↻** 键，进行花样号码选择设定。

(2) 按 **+** / **-** 键、**+** / **-** 键，画面上显示出 14。（14 号花样开启方法：请参考 2.6.2 用户参数设置举例 3. 花样号读取设定）。

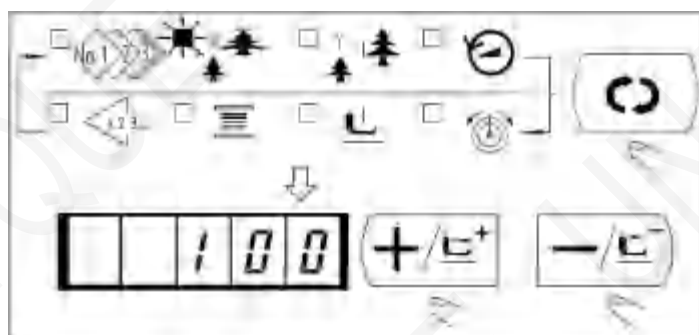
（设定为 14 号花样）



## 3. X 放大缩小率的设定



- (1) 按  键, 进行 X 放大缩小率的设定。
- (2) 按  键、 键, 让缝纫机显示出 100。  
(把 X 放大缩小率设定为 100%)



## 4. Y 放大缩小率的设定



- (1) 按  键, 进行 Y 放大缩小率的设定。
- (2) 按  键、 键, 让缝纫机显示出 100。  
(把 Y 放大缩小率设定为 100%)



## 5. 最高转速限制的设定



- (1) 按  键, 进行转速的设定。
- (2) 按  键、 键, 让缝纫机显示出 400。(设定为 400rpm)
- (3) 按 R 键恢复系统默认值, 即最高转速。

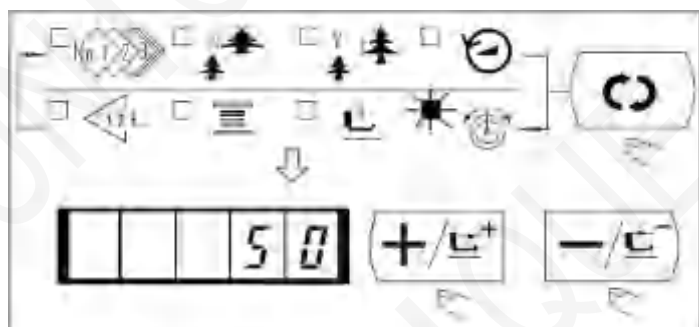

## 6. 线张力的设定





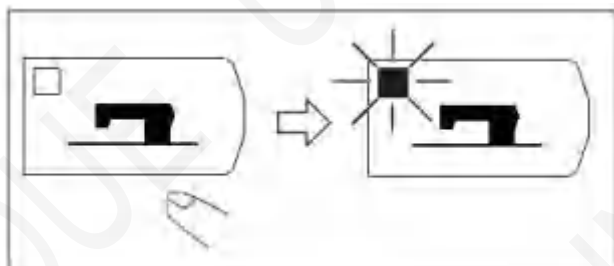

- (1) 按  键, 进行线张力的设定。
- (2) 按  键、 键, 让缝纫机显示出 50。  
(可以在 0~200 的范围内进行设定)

## 7. 设定结束



- (1) 按  键。
- (2) 压脚移动上升后，缝制 LED 亮灯，成为可以缝制的状态。
- (3) 如果再次按下  键，缝制 LED 灯熄灭，可重新设定各数据项目。

- 按下  键后，花样号、XY 放大缩小率等设定值被记忆。
- 按下  键后，可以重新确认各设定项目，但是缝制 LED 亮灯的状态不能变更。
- 按下  键后，缝制 LED 灭灯，各项目的设定值可以变更。
- 线张力在缝制 LED 亮灯时也可以变更，踩下踏板时可以记忆。
- 当花样号为 0（出厂设置）时，按下  键后，会显示错误 E-10，此时，按下复位键后请重新确定花样号。
- 不按  键，关掉电源后，花样号、XY 放大缩小率、最高转速、线张力的设定值均不能被记忆。

### 2.4.2 花样形状的确定

选择花样后，请一定确认花样的形状。

万一花样远离压脚或者超出压脚范围，在缝制途中就会碰到压脚，弄断机针。

- (1) 试缝

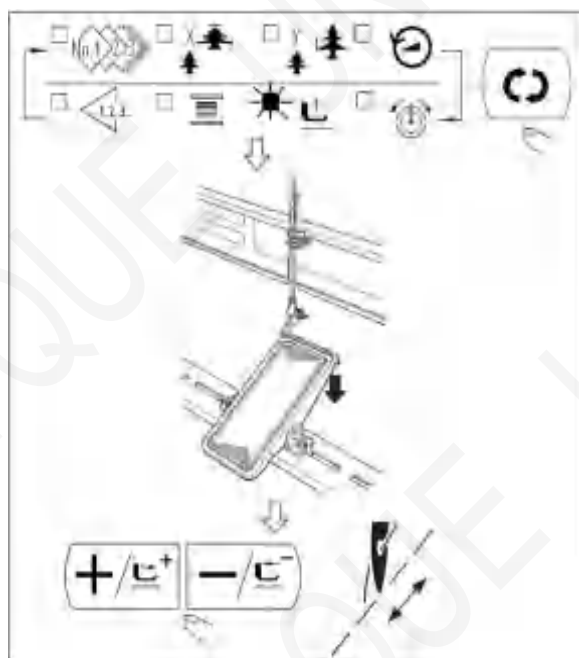

1. 按 键，缝制 LED 灯亮起。
2. 用 键选择压脚下降 ，屏幕显示“SinGL”；踩脚踏板让压脚下降。
3. 在压脚下降后的状态，按 键
4. 用 键、 键确认形状；确认缝制的花样在压脚允许的范围
5. 按 键让压脚上升，回到起缝位置。

用 键，解除 选定（选定除 外的其他数据项目）后，可以踩踏板从当前

针位置开始缝制。

## (2) 穿线

1. 保证缝制 LED 在熄灭的（未准备）状态，如果缝制 LED 灯已亮起，按 键将其熄灭。
2. 用 键选择压脚下降 ，屏幕显示 。
3. 按 键将压脚降下进入穿线状态，屏幕显示 。注意在此显示状态下，无法按 键切换选择项目。
4. 完成穿线后，再按 键退出穿线模式。

## 2.4.3 缝制

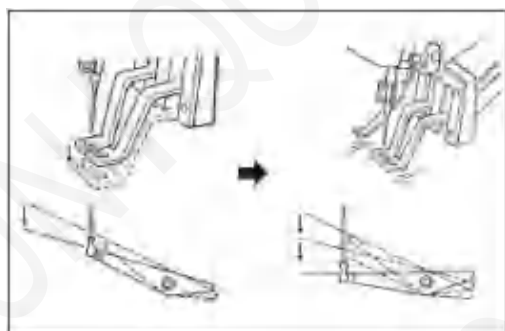

### 缝制：

1. 把缝制品放到压脚部。
2. 踩踏板开关至第一级，，压脚下降；松开踏板后，压脚上升。
3. 踩踏板开关至第二级之后开始缝制。
4. 缝制结束后，压脚上升返回到起始缝的位置。





**注意 1：** 将踩踏板开关至第一级，压脚下降，按 键、 键可以改变花样的缝制位

置；然后将踏板开关位置踩至第二级，缝纫从选定的位置开始。在缝制过程中，如出现断线等现象时，排除故障后，可以使用此方法进行补缝。

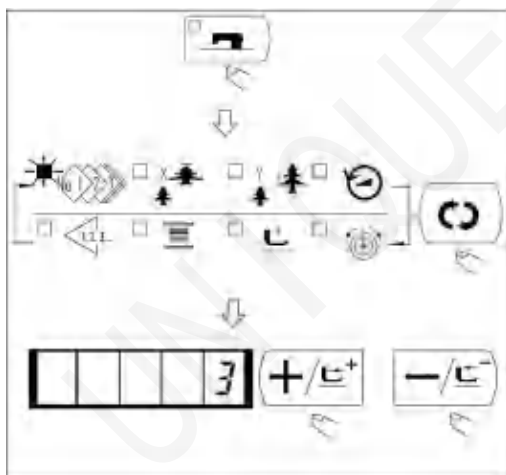
**注意 2:** 不要将注意 1 中的做法用作花样试缝操作，以免万一误将踏板开关踩至第二级，引起机器启动而发生危险。花样的试缝操作必须严格按照【2.4.2 花样形状的确定（试缝）】一节中的步骤进行操作。

#### 2.4.4 变更为其它花样



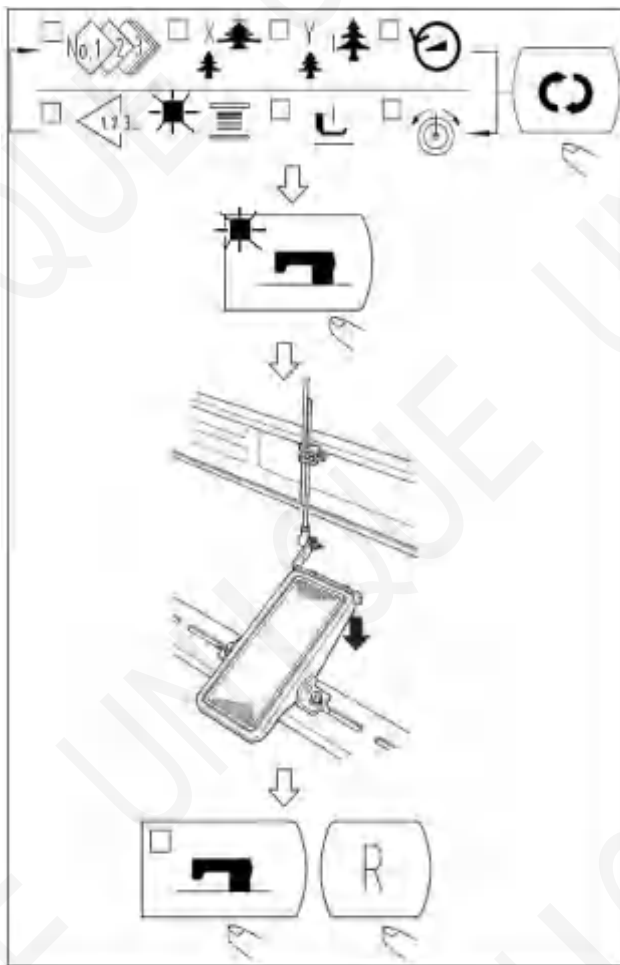

1. 按  键，缝制 LED 灯灭。
2. 按  键，选择花样号设定项目。
3. 用  键、 键设定花样号。
4. 同样地设定 XY 放大缩小率、转速等。
5. 按  键之后，缝制 LED 灯亮起，成为可以缝制的状态。

## 2.4.5 绕线





刚打开电源后，绕线不动作。请设定 1 次花样号后，按  键让缝制 LED 灯亮起之后再行如下操作：

1. 再按  键，缝制 LED 灯熄灭。
2. 按  键，选择绕线  屏幕显示：



(如果缝制 LED 灯亮起时不能选择)

3. 按  键，压脚下降，缝制 LED 灯亮起。
4. 踩踏板开关后，缝纫机开始转动，缝制 LED 灯亮起。
5. 踩踏板开关之后，或者按  键之后缝纫机停止转动，缝制 LED 灯熄灭。

## 2.4.6 抓线装置

用抓线装置可以防止高速开始时的缝制不良（上线脱线、跳针、上线脏污）。抓线在抓线显示 LED 亮灯的状态动作，灭灯状态下不动作。动作 ON/OFF 的变换可以用  键来进行。抓线装置 OFF 时，自动进行低速起动的。

当存储参数号 35 设定为 1（禁止）时不进行抓线动作。同时， 键无效。

\*使用抓上线时注意事项：

- (1) 有（动作）抓线时，请把缝制开始上线的长度调小之后再使用。

机针长度过长的话，布料背面的线会被拉出，同时，过长的话，容易把上线抓线的上线端头缝进缝迹里。

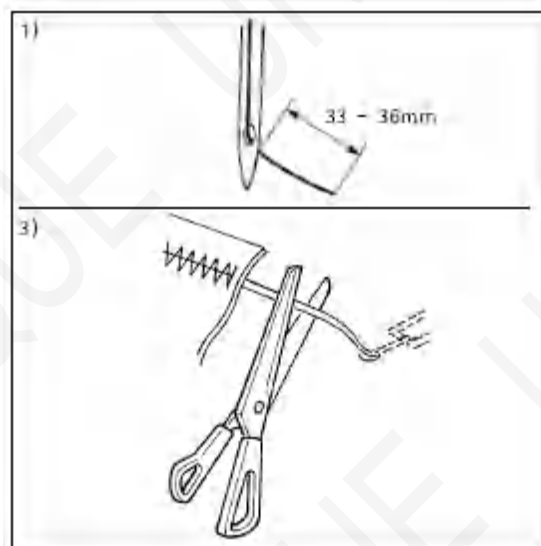

1. 有抓线时的机线长度为 33 - 36mm。
2. 更换机线之后等机线变长，或用手拿机线进行缝制时，请把抓线  设为 OFF。
3. 如果抓线夹持的上线被缝进缝迹后，亦不要强行拉布料，请用见到等把缝进布料的上线剪掉，开始缝制的上线不会被缝进缝迹里。

(2) 让抓线动作，可以保持缝制开始的稳定缝制，可以把机针调整短，一次布料的上线现象变少，但是，对于为了漂亮的卷进上线但是缝迹长度不足的图案等，布料背面有可能挑出上线，请参考下列事项适当地选择有无抓线功能。

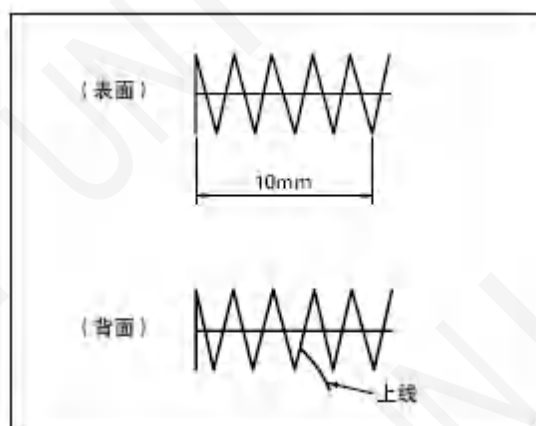

1. 缝制长度短（约为 10mm 以下）时，把机线调短，但是有时也出现胡须状等情况。

(3) 使用布料不与针板②紧密接触的下板①时，有可能发生上线松弛，不管线长度如何布料背面均卷入上线的现象。

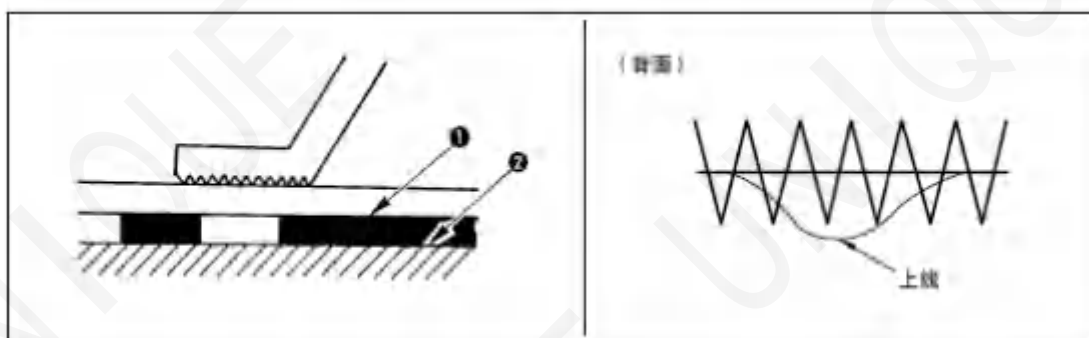

(4) 用抓线功能，缝制开始的底线露出布料表面时，把缝制开始的张力（2-3 针）降低，底线就明显了。

[设定举例] 缝制张力设定为「35」时，缝制开始 1-2 针的张力为「20」。

#### 2.4.7 底线计数器

计数器的设定在出厂状态时设定为生产计数器（加算方式）。而作为底线计数器（减算

方式) 时, 必把 No.18 号参数的值设置为 1 (具体设置方法: 请参考 2.6.2 用户参数设置举例 4.计数器动作的设定)。

计数器设定为生产计数器 (加计数) 时: 按 +\- 按键可进行计时器中缝制数量的设置, 按 R 键可将计数器中的缝制数量清除。

计数器设定为底线计数器 (减计数) 时: 在设置成底线计数器 (减计数) 后, 不能直接进行缝制数量的修改, 必须先按 R 键后再按 +\- 按键方可进行缝制数量的设置。

**注意:** 计数器为生产计数器 (加计数) 时, 缝制的数量达到 9999 后如再次进行缝制, 计数器则会重新从 0 开始计数; 计数器为底线计数器 (减计数) 时, 当缝制的数量为 0 后面板自动显示为 “0”, 同时数码管闪烁, 按 R 键恢复到设定值后才能继续进行缝制。

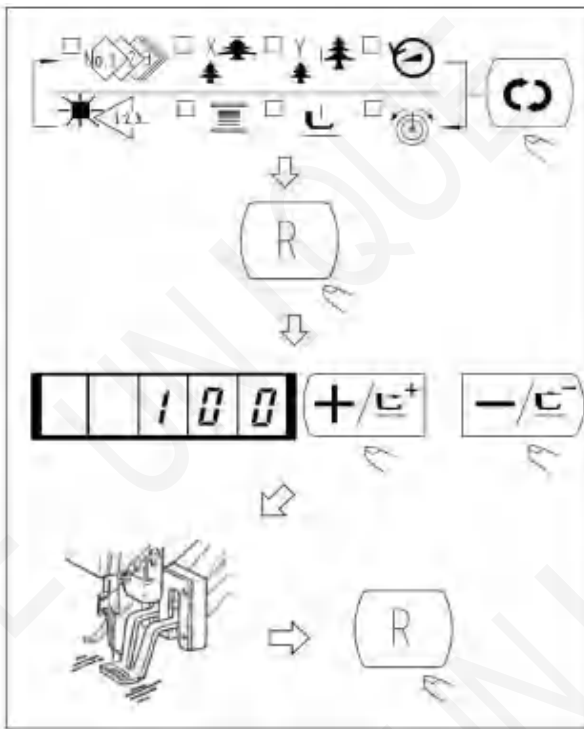

1) 按 键, 设定为计数器显示

2) 然后按 键。

3) 然后, 按 键、 键, 设定一个旋梭可以缝制的次数。

4) 缝制后, 每逢一次计数器减一。

5) 缝制完设定数后, 蜂鸣器鸣响, 同时显示屏闪烁提示计数器已归零。

6) 更换底线, 按 键, 计数器值返回到设定值。

7) 反复 4) ~6) 的步骤。

## 2.4.8 暂停

1、踏板急停功能: 新型脚踏板分为三档, 1 档压脚下降; 2 档正常缝制; 3 档为急停档。



1) 按下准备键后向前 踩脚踏板, 压脚下降;

2) 再次向前 踩脚踏板便开始缝制;

3) 在缝制过程中, 如果需要急停, 您可以向后 踩一下脚踏板, 机器进入急停, 面板显示 “E 50”。



## 2、面板急停

把 31 号参数设定为 1 之后,  $\text{R}$  键可以作为暂停键来使用。

按  $\text{R}$  键, 缝纫机停止转动, 显示 “E 50”。

## 3、两种急停后的剪线和手动移框操作

- 1) 在急停后显示 “E 50” 的状态下, 按  $\text{R}$  键清除错误信息, 机器会执行剪线动作, 面板显示变为 “MovE”, 表示手动移框状态;
- 2) 此时可以通过按  $\text{+}/\text{c}^+$  键、 $\text{-}/\text{c}^-$  键对送布进行手动移框, 然后踩踏板 2 档继续完成本次缝纫, 也可以按  $\text{R}$  键返回到原点。

### 2.4.9 图案线张力的设定

花样开始的 6 针和从下线曲折变换的部分以及缝制结束的加固部分的上线张力可以分别进行设定。

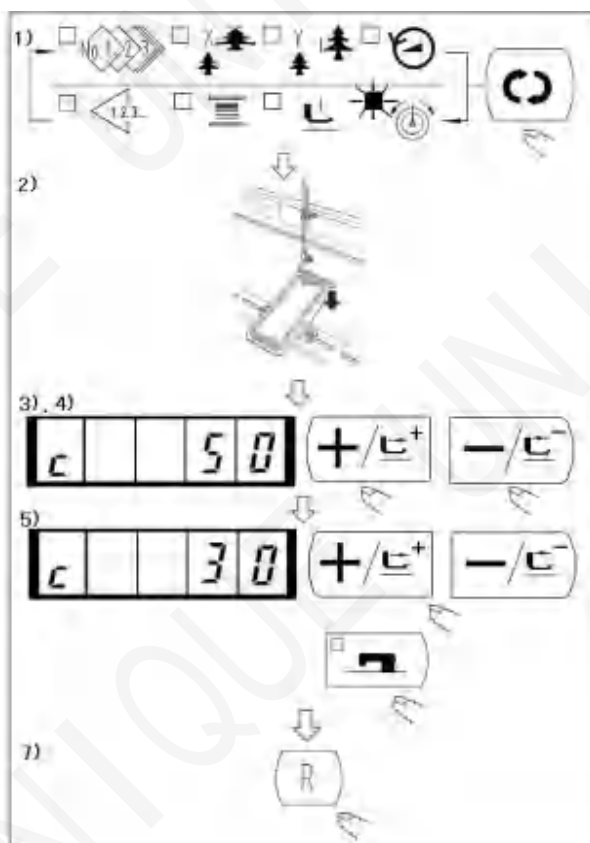

- 1) 缝制 LED 亮灯时, 按  $\text{c}$  键, 进行线张力  $\text{c}$  设定。
- 2) 踩脚踏板至第一级, 压脚下降。  
(如果把脚踏板踩到最后, 缝纫机会开始缝制。)
- 3) 用  $\text{+}/\text{c}^+$  键、 $\text{-}/\text{c}^-$  键移动送布。
- 4) 在可以设定张力的位置, c 被显示出来。
- 5) 一边按  $\text{c}$  键, 一边用  $\text{+}/\text{c}^+$  键、 $\text{-}/\text{c}^-$  键设定张力。
- 6) 反复 3、4、5 设定张力。
- 7) 设定结束之后, 按  $\text{R}$  键, 压脚移动到原点然后上升。

## 2.5 设置 P 花样与 C 花样

### 2.5.1 使用花样键进行缝制

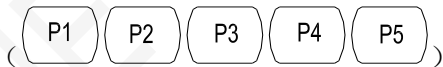

把已经存储的花样 (1~200) 可以登记到 P1~P99 上。变更放大缩小率、最高转速限制、线张力、缝制位置就可以登记, 用花样的滚动窗口选择同样可以登记花样, 可以一次地叫出 P1~P25。

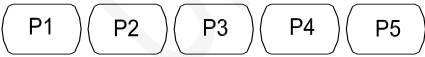
• 当选择了 P6~P25 时, 用下表所示的  键的组合 (同时按) 进行缝制。



P-No.	选择键	P-No.	选择键	P-No.	选择键	P-No.	选择键
P1	P1	P8	P1+P4	P15	P4 +P5	P22	P2+P3+P4
P2	P2	P9	P1+P5	P16	P1+P2+P3	P23	P2+P3+P5
P3	P3	P10	P2+P3	P17	P1+P2+P4	P24	P2+P4+P5
P4	P4	P11	P2+P4	P18	P1+P2+P5	P25	P3+P4+P5
P5	P5	P12	P2+P5	P19	P1+P3+P4		
P6	P1+P2	P13	P3+P4	P20	P1+P3+P5		
P7	P1+P3	P14	P3+P5	P21	P1+P4+P5		

#### 1. 花样键上的登记

例: 把花样 No.3、X 放大缩小 50%、Y 放大缩小 80%、最高速度限制 2000rpm、线张力 50、花样位置右移 0.5mm、前移 1mm 的设定到 P2。

1) 打开电源, 按  键 (缝制 LED 应该熄灭)。进入方式设定 (存储器开关设定)。



2) 用  键、 键显示出花样存储模式。



3) 按  键, 缝制 LED 灯亮起, 进入花样存储方式。

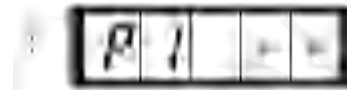









4) 按  键。(选择存储的 P-No.)  
用 + 键、- 键也可以选择。







5) 用  键, 显示花样号 。







用  键、 键设定花样号码。

- 6) 按  键，用  键、 键设定为 X 放大缩小率  “50”%、Y 放大缩小率  “80”%、最高速度限制  “2000”rpm、线张力  “50”。



- 7) 按  键后，变为 X 放大缩小率  显示为 0.0。X 方向的移动量可以以 0.1mm 为单位进行设定。用  键、 键设定 0.5。按 R 键时，所有参数均恢复原始设置。



- 8) 按  键后，变为 Y 放大缩小率  显示为 0.0。Y 方向的移动量可以以 0.1mm 为单位进行设定。用  键、 键设定 1.0。按 R 键时，所有参数均恢复原始设置。



- 9) 按  键后，设定结束。



- 10) 按  键，结束花样存储方式。



- 11) 按  键，结束方式设定，返回通常方式。

## 2. 缝制操作

操作例：以存储的 P2 内容进行缝制，然后缝制 P3 的内容。

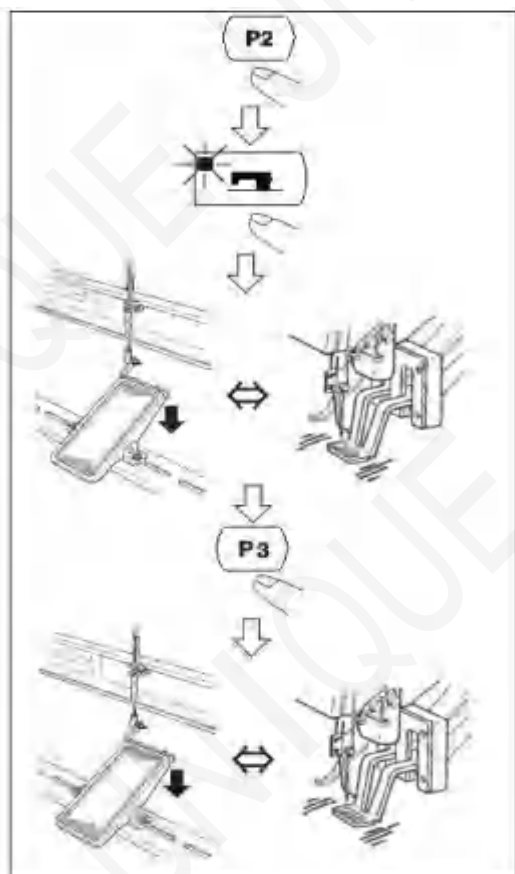

1. 打开电源。
2. 按 **P2** 键。
3. 按  键，缝制 LED 亮灯后，压脚移动上升。
4. 确认花样形状。
5. 如果花样形状正确，则可以缝制。
6. 缝制结束后，按 **P3** 键，压脚下降，检索原点，移动到缝制起始点，然后压脚上升。  
(P 键在缝制 LED 亮灯时，也可以按键变换花样。)
7. 进行 4、5 项操作。

### 2.5.2 使用组合功能的缝制





按顺序排列已经存储的花样存储 (P1~P99)，存储到 C1~C50，每次缝制之后按顺序变换缝制花样。1 个组合号码最多可以存储 99 个花样。

#### 1. 组合花样的存储





例：按 P1、P2、P3 的顺序组合进行存储。

- 1) 打开电源，按 **M** 键 (缝制 LED 应该灭灯)。进入方式设定 (存储器参数设定)。
- 2) 用 **+/-<sup>+</sup>** 键、**-/-<sup>-</sup>** 键显示组合模式。
- 3) 按  键，缝制 LED 亮灯，进入组合花样设定方式。用 **+/-<sup>+</sup>** 键、**-/-<sup>-</sup>** 键可以选择 C1~C50。

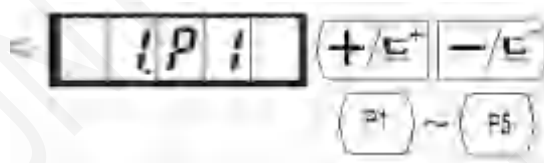





- 4) 按  键, 然后按  键。P1 被设定到 C1 的第 1 个花样。用  键、 键选择 P1~P99。

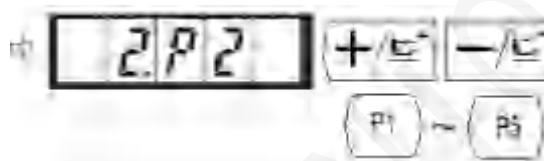

- 5) 按  键, 然后按  键。P2 被设定到 C1 的第 2 个花样。用  键、 键选择 P1~P99。按 R 键可重新选择。



- 6) 按  键, 然后按  键。P3 被设定到 C1 的第 3 个花样。用  键、 键选择 P1~P99。



- 7) 按  键结束存储。



- 8) 按  键结束组合花样存储模式。



- 9) 按  键结束方式设定, 返回通常方式。



## 2. 缝制操作

操作例: 以存储的 C1 内容进行缝制。

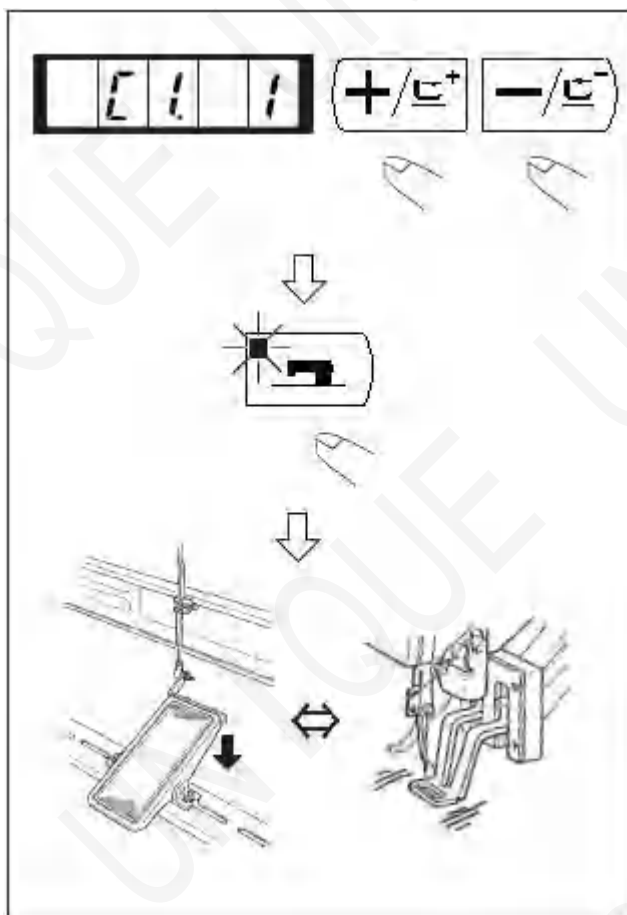

- 1) 打开电源。
- 2) 用  $\boxed{+/C^+}$  键、 $\boxed{-/C^-}$  键把花样号设定为 C1.1。
- 3) 按  $\boxed{\text{LED}}$  键，缝制 LED 亮灯，然后压脚移动上升。
- 4) 如果花样形状良好，则可以缝制。
- 5) 按照每次缝制组合的顺序进行缝制，最后一个花样缝制结束后，返回第一个花样，反复进行缝制。

- ◇ 缝制后，如果想返回前面的图案或跳到下一图案时，可以在缝制 LED 亮灯的状态按  $\boxed{+/C^+}$  键、 $\boxed{-/C^-}$  键，图案显示变化，压脚移动到缝制起始点。
- ◇ 存储 C1~C50 后，若改变 P1~P99 的话，存储在 C1~C50 中的 P1~P99 的内容也改变。
- ◇ 每种花样都应该确认花样形状。

## 2.6 用户参数设置

### 2.6.1 用户参数设置的具体操作





- 1) 缝制 LED 灭灯的状态下，按  $\boxed{M}$  键之后，进入用户参数设置模式。

(按  $\boxed{M}$  键之后，显式的 1.30 表示第一号参数的最高速度限制为 3000rpm。)

- 2) 参数号码可以用  $\boxed{+/C^+}$  键、 $\boxed{-/C^-}$  键进行变更。

- 3) 按  $\boxed{\text{LED}}$  键，调整想变更的参数号码，缝制 LED 亮灯。



- 4) 用  键、 键变更参数对应值。
- 5) 按  键，可以返回出厂设置。
- 6) 再次按  键，存储变更内容，缝制 LED 灭灯，返回参数号码选择状态。
- 7) 再次按  键，结束参数设定方式，返回通常状态。



## 2.6.2 用户参数设置举例

### 1. 缝制速度上限的设定



设定例：把缝制速度的上限设定到 1800rpm。

- 1) 在缝制 LED 灭灯的状态按  键，显示为参数号 1 的内容。缝纫机的最高速度显示用参数号 1 设定。





- 2) 在显示参数号 1 的状态下，按  键，缝制 LED 亮起。参数号 1 的内容被显示。



- 3) 用  键、 键设定为“1800”。



- 4) 按  键存储，缝制 LED 灯灭。

- 5) 按  键，返回通常状态。

### 2. 缝制开始软启动速度的设定





缝制开始的第 1 针～第 5 针的速度可以以 100rpm 为单位进行设定。可以设定为有抓线和无抓线。

有抓线时

	出厂设置 (rpm)	设定范围
第 1 针	1500	400~1500
第 2 针	3000	400~3000
第 3 针	3000	400~3000
第 4 针	3000	400~3000
第 5 针	3000	400~3000

有抓线时，变更为第 1 针 1500→1000rpm、第 2 针 3000→2000rpm。

设定举例:

- 1) 缝制 LED 灭灯的状态下, 按 **(M)** 键。
- 2) 用 **(+/-<sup>+</sup>)** 键、**(-/-<sup>-</sup>)** 键选择参数号 2, 这里设定第 1 针的缝纫机速度。
- 3) 按 **()** 键, 缝制 LED 亮灯, 第 1 针的设定值被显示出来。
- 4) 用 **(+/-<sup>+</sup>)** 键、**(-/-<sup>-</sup>)** 键设定其值为“1000”。  
按 **(R)** 键则返回出厂设置。按 **(M)** 键后, 当前的操作全被取消, 返回 2) 的状态。
- 5) 按 **()** 键, 缝制 LED 灯灭, 第 1 针的设定值被存储。
- 6) 用 **(+/-<sup>+</sup>)** 键、**(-/-<sup>-</sup>)** 键选定参数号 3, 这里设定第 2 针的缝纫机速度。
- 7) 按 **()** 键, 缝制 LED 亮灯, 第 2 针的设定值被显示出来。
- 8) 用 **(+/-<sup>+</sup>)** 键、**(-/-<sup>-</sup>)** 键设定其值为“2000”。  
按 **(R)** 键则返回出厂设置。按 **(M)** 键后, 当前的操作全被取消, 返回 6) 的状态。
- 9) 按 **()** 键, 缝制 LED 灯灭, 第 2 针的设定值被存储。
- 10) 按 **(M)** 键, 结束参数设定方式, 返回通常状态。

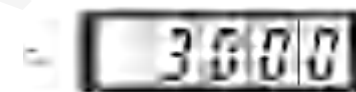
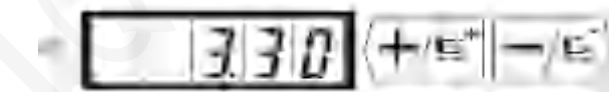
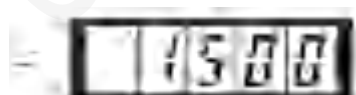

### 3. 花样号读取设定

设定为不要的花样不能读出，防止错误的花样调出。另外，可调出可以使用的需要花样。  
设定例：把 2 号花样和 3 号花样设定为不能读出。

1) 在缝制 LED 灭灯的状态下，按  键。



2) 用  键、 键显示出参数号 201。



3) 按  键，缝制 LED 亮灯，图案 No.1 的设定值被显示出来。设定值 1：可以读出，0：不能读出。





4) 用  键、 键设定为花样 No.2。



5) 按  键，把设定值设定为 0。



6) 用  键、 键设定为 No.3。

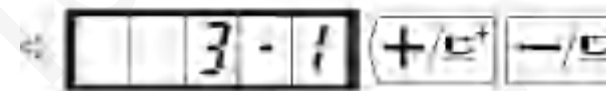

7) 按  键，把设定值设定为 0。



8) 按  键，存储设定值，缝制 LED 灭灯。



9) 按  键，结束参数设定方式，返回通常状态。

#### 4. 计数器动作的设定

设定例：把生产计数器（加算方式）变更为底线计数器（减算方式）。

1) 在缝制 LED 灭灯的状态下，按  键。



2) 用  键、 键显示出参数号 18。



3) 按  键，缝制 LED 亮灯，计数器动作的设定值被显示出来。

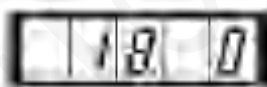

4) 按  键把设定值设定为 1。



设定值 0: 生产计数器, 1: 底线计数器。

5) 按  键，存储设定值，缝制 LED 灭灯。

6) 按  键，结束参数设定方式，返回通常状态。

### 2.6.3 用户参数设置表

参数号	功能	调整范围	初值	备注
1.30	缝制的最高速度。 (可以以 1000rpm 为单位设定)	400~3000	3000	
2.15	第 1 针的缝制速度。(抓线) (可以以 100rpm 为单位设定)	400~1500	1500	
3.30	第 2 针的缝制速度。(抓线) (可以以 100rpm 为单位设定)	400~3000	3000	
4.30	第 3 针的缝制速度。(抓线) (可以以 100rpm 为单位设定)	400~3000	3000	
5.30	第 4 针的缝制速度。(抓线) (可以以 100rpm 为单位设定)	400~3000	3000	
6.30	第 5 针的缝制速度。(抓线) (可以以 100rpm 为单位设定)	400~3000	3000	
7.--	第 1 针的线张力 (抓线)	0~200	200	
8.--	切线时的线张力	0~200	0	
9.--	切线时的线张力变换同步时间	-6~4	0	
10.4	第 1 针的缝制速度。(不抓线) (可以以 100rpm 为单位设定)	400~1500	400	

11.9	第 2 针的缝制速度。(不抓线) (可以以 100rpm 为单位设定)	400~3000	900	
12.30	第 3 针的缝制速度。(不抓线) (可以以 100rpm 为单位设定)	400~3000	3000	
13.30	第 4 针的缝制速度。(不抓线) (可以以 100rpm 为单位设定)	400~3000	3000	
14.30	第 5 针的缝制速度。(不抓线) (可以以 100rpm 为单位设定)	400~3000	3000	
15.--	第 1 针的线张力(不抓线)	0~200	0	
16.--	缝制开始的线张力(不抓线)变换同步时间。	-5~2	0	
17.0	XY 扩大缩小率, 最高转速限制的显示, 以及变更可否。	0: 可变更 1: 不可变更	0	
18.0	计数器动作	0: 生产计数器 (加算) 1: 底线计数器 (减算)	0	
25.1	压脚分段开关	0: 压脚分段 1: 禁止压脚分段	1	
26.70	2 级行程时压脚分段高度调整	50~90	70	
31.0	可以用操作键盘(清除键)停止缝纫机动作	0: 无效 1: 操作盘复位键	0	
32.1	可以禁止蜂鸣音响	0: 不响蜂鸣音 1: 操作盘操作音 2: 操作盘操作音和报警提示音	2	
33.2	设定抓线开放的针数	1~7 针	2	
34.--	可以推迟抓线的同步时间	-20~0	0	
35.1	可以禁止上线抓线控制	0: 通常 1: 禁止	1	
36.--	选择送布动作的同步时间 紧线不好时设定为一方向	-8~16	12	

37.1	缝制结束后压脚状态选择	0: 先回起缝点再抬压脚; 1: 回起缝点同时抬压脚;	1	
39.0	缝制结束后是否检索原点	0: 不检索原点 1: 检索原点	0	
40.0	设定循环缝制时的原点检索	0: 不检索原点 1: 每 1 图案结束	0	
41.0	设定 P 花样缝制时的原点检索	0: 不检索原点 1: 检索原点	0	
42.0	设定针杆停止位置	0: 上位置 1: 上死点	0	
46.0	可以禁止切线	0: 通常 1: 禁止切线	0	
49.16	可以设定卷线速度	800~2000	1600	
55.0	钉扣禁止起缝加固设置	0: 起缝加固 1: 起缝不加固	0	
62.0	花样升级	0: 普通模式 1: 导入(追加)花样, 如果导入的花样号已经存在则进行覆盖 2: 导出所有外置花样到 USB 存储设备 3: 清除(格式化)面板外置花样存储区域	0	
63.0	XY 缩放率设定方法	0: 按百分比设定 1: 按尺寸设定	0	
97.1	暂停后的切线方式	0: 自动切线 1: 手动切线	1	
135.0	起缝前压脚动作顺序	0: 压脚在起缝点待命 1: 压脚在起点待命	0	
167.5	机头 LED 照明灯亮度	0~10	5	值越大亮度越高 0 表示关闭

201.--	设定是否可以读出图案数据	0: 不能读出 1: 可以读出	机型 不同 则设 定不 同	
212.0	气阀分离压脚下降顺序	0: 同时下降 1: 先下降左再 下降右 2: 先下降右再 下降左	0	
213.0	气阀分离上升顺序	0: 同时上升 1: 先上升左再 上升右 2: 先上升右再 上升左	0	
214.1	翻转压脚使能	0: 禁止 1: 使能	1	
P----	进行图案登记			
C----	进行循环缝制登记			

### 3 服务参数设置

服务参数有别于普通参数，一般禁止用户自行更改，这些参数提供给专业技术人员，供其调试时使用。

#### 3.1 服务参数的开启和变更

在缝制灯熄灭的状态下，按 **(M)** 键，显示 ，然后同 **(P1)** **(P3)** **(P5)** 时按键，听到蜂鸣器响声后，就能对服务参数进行启动与变更。

服务参数的修改与普通参数相同，具体操作方法可参考【2.6 用户参数设置】一节。

#### 3.2 服务参数列表

参数号	功能	调整范围	初值	备注
19.30	气动外压脚上升时间	0~90	30	
21.--	标准踏板、踏脚开关位置	50~200	70	
22.--	标准踏板、高低段行程开关位置	50~200	120	
23.--	标准踏板、启动开关位置	50~200	185	
24.0	脚踏板类型	0: 模拟单踏板 1: 数字单踏板 2: 双踏板 3: 双踏板, 但只运行踏板起控制作用	0	
27.--	踩踏板时压脚下降速度	100~4000pps	4000	
28.--	踩踏板时压脚上升速度	100~4000pps	1500	
29.--	缝制结束时切线压脚上升速度	100~4000pps	3000	
38.0	压脚不上升时, 只通过启动开关可进行缝制	0: 普通 1: 禁止抬压脚	0	
43.4	切线时的机器旋转数选择	3~7	4	
44.0	切线时在易于切线的方向选择有无送布的操作	0: 无送布 1: 有送布	0	
45.16	切线时进行送布的针孔导向直径 (可设定以 0.2mm 为单位)	16~40 (1.6mm~4.0mm)	16	

56.--	+X 方向（右侧）的移动限定范围	0~50mm	20	
57.--	-X 方向（左侧）的移动限定范围	0~50mm	20	
58.--	+Y 方向（后面）的移动限定范围	0~30mm	15	
59.--	-Y 方向（前面）的移动限定范围	0~30mm	15	
64.0	拨线方式选择	0: 电磁铁拨线 1: 电机拨线	1	
65.--	显示系统各部件软件版本	1.PAnL: 显示操作面板软件版本 2.CtrL: 显示下位机软件版本 3.dSP1: 显示步进驱动 DSP1 软件版本 4.dSP2: 显示步进驱动 DSP2 软件版本		进入各级子菜单显示详细信息
66.45	压脚联动拨线操作脉冲数	30~60	45	
67.8	默认参数调用	0~90	依机型而定	需重新上电生效
70.--	更新系统固件程序	1-PnL: 更新面板固件程序 2-Ctr: 更新主控固件程序		进入各级子菜单进行操作
74.1	压脚控制模式切换	0: 气阀控制 1: 电机控制	1	
95.--	剪线角度	-10~10	0	
102.7	X 步进电机全流参数	0~15	7	需重新上电生效
104.11	Y 步进电机全流参数	0~15	11	需重新上电生效
106.2	抓线步进电机全流参数	0~15	2	需重新上电生效
108.14	压脚步进电机全流参数	0~15	14	需重新上电生效
109.7	X 步进电机半流参数	0~15	7	需重新上电生效

110.6	Y 步进电机半流参数	0~15	6	需重新上电生效
111.5	压脚步进电机半流参数	0~15	5	需重新上电生效
112.--	主轴停车补偿	-10~10	0	
121.0	计数器锁定	0: 可清零可加减; 1: 可清零不可加减; 2: 不可清零可加减; 3: 不可清零不可加减	0	需输入密码解锁才能显示
120.--	加润滑油报警针数	3000~12000	5000	单位: 万针
122.--	OC 长度微调	-128~128	0	
123.--	OD 长度微调	-128~128	0	
124.--	BD 长度微调	-512~512	0	
125.--	OC 长度	1780~2380	2080	
126.--	OD 长度	1440~2040	1740	
127.--	BD 长度	430~630	530	
128.0	步进驱动类型设定	0: DSP1 闭环, DSP2 闭环; 1: DSP1 开环, DSP2 闭环; 2: DSP1 闭环, DSP2 开环; 3: DSP1 开环, DSP2 开环;	0	需重新上电生效
136.--	分线延时	-10~30	0	
137.--	起针夹线器松开角度	-150~150	0	
138.--	起针夹线器剪线后夹紧时间	-1~1	0	
140.0	线张力控制方式	0: 电子夹线 1: 机械夹线	0	
141.--	支线张力电磁铁吸合力度微调	-20~20	0	
142.--	支线张力电磁铁保持力度微调	-40~40	0	

150.0	机头翻起安全开关可以无效	0: 普通 1: 机头翻起安全形状无效	0	
163.0	中压脚控制方式	0: 无中压脚控制 1: 未使用 2: 电磁铁控制中压脚 3: 机械控制中压脚	0	
174.1	剪刀位置传感器使能	0: 禁用 1: 开启	1	
241.0	功能选择	0: 套结（加固） 5: 花样套结 7: 钉扣	0	
245.--	加油报警错误清除	按 R 键清除	显示机器累计运转针数	
268.--	密码管理	0.LoCk: 加密锁定 1.UkCH: 机修工密码检测 2.UkMo: 机修工密码修改 3.UkCL: 机修工密码恢复 4.kkCH: 核心密码检测 5.kkMo: 核心密码修 6.kkCL: 核心密码恢复	0.LoCk	进入各级子菜单显示详细信息
CP---	系统检测模式			

注：以上参数只供维修人员使用，用户不能轻易改动。

### 3.3 恢复出厂默认设置

当用户无意中修改了某些出厂时设置好的参数或者电控系统出现故障时，可以尝试使用“恢复出厂默认设置”功能，进行系统恢复。

**注意：**恢复出厂默认设置，用户以前设定的数据参数将会被覆盖，使用此功能时，请慎重考虑，如不清楚，应及时联系厂家技术人员，在其指导下进行操作。

具体操作步骤如下:

1. 在缝制灯熄灭的状态下, 按 **(M)** 键, 显示 **130**, 然后同时按 **(P1)** **(P3)** **(P5)** 键, 听到蜂鸣器响声后, 即开启了服务参数变更;
2. 按 **+/-**、**-/-** 键, 选择 67 号参数:

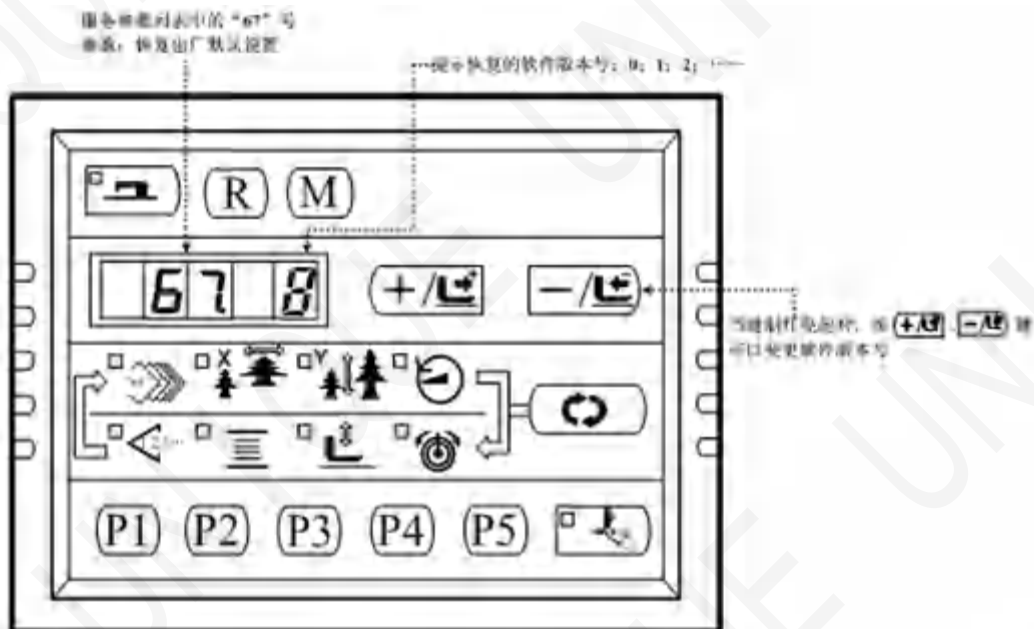

3. 按 **缝制灯** 键, 缝制灯亮起, 然后按 **+/-**、**-/-** 键, 可以选择需要恢复的项目:  
67=0: 恢复面板参数; 67=25: 恢复电控机头板参数;

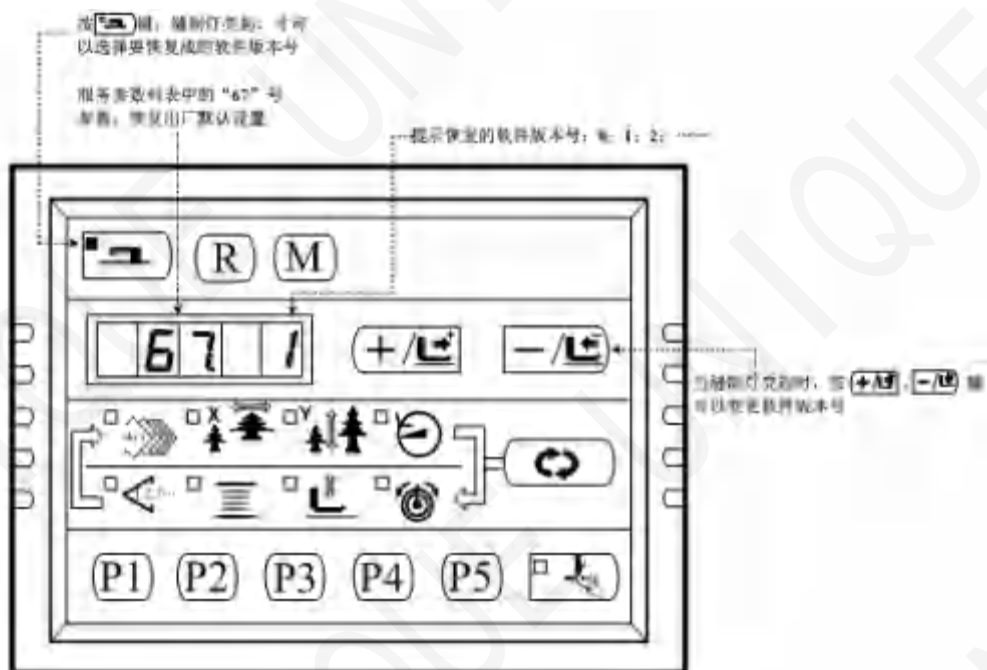

4. 选择好需要恢复的项目后, 按 **缝制灯** 键确认要恢复成的版本号, 缝制灯灭, 面板显示 “Po

FF”提示关闭电源（如果选择的是恢复机头板参数，会先显示“EEP”然后再显示“PoFF”，此时关闭电控电源，然后再打开电源。（注：如果选择的不是有效的值，则不能进行恢复）

按 **(M)** 键，退出服务参数设置模式，返回到普通缝制模式；

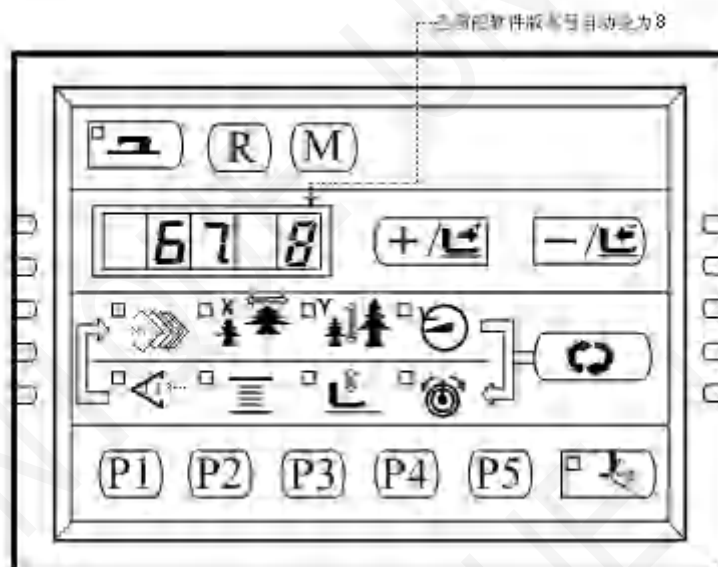

5. 上电后，面板显示“init”表示正在进行参数恢复操作（如果选择的是恢复机头板参数，再次上电就已经完成参数恢复可以直接使用），经过几秒钟时间后面板显示缝制界面 1 号花样，表示恢复参数完毕，可以正常使用。



**注意：**在再次打开电源，给系统上电，系统进行恢复过程中，如果断电，恢复过程将被迫中断，将不能完成恢复出厂默认设置，返回到恢复之前的软件状

### 3.4 软件版本显示

在参数设置模式下，通过 65 号参数可以进入下一级子菜单，有 4 项子项目可以显示系统的软件版本情况：

上电后先开启服务参数，然后按 、 键将面板显示改为“65.--”，再按 

键，缝制灯亮起进入软件版本显示模式。此后按 、 可以切换要显示的项目：

- 1.PAnL：显示操作面板软件版本
- 2.CtrL：显示下位机软件版本
- 3.dSP1：显示步进驱动 DSP1 软件版本
- 4.dSP2：显示步进驱动 DSP2 软件版本

选择需要显示的项目，例如想要显示操作面板的软件版本信息，在面板显示“1.PAnL”的时候，按一下  键进入详细信息显示界面。

此时花样号灯点亮，数码管显示“—A”（也可能是其他字母，视软件版本而定），表示厂家信息，通过按  键，可以循环点亮 X、Y 缩放率，转速、线张力这 5 个 LED 灯，并在数码管上显示出软件版本的详细信息，各 LED 点亮时数码管显示的意义格式如下表：

花样号 LED	X 缩放率 LED	Y 缩放率 LED	转速 LED	线张力 LED
—A	MA201	15	1.	2.
厂家代码	机型信息	软件版本号	软件父版本号	软件子版本号

上述信息综合可表述为：MASC201-A-V1.2.15。



对于不同的机型，机型信息显示意义如下：

机型信息项显示内容	机型含义
SC201	第三代（步进开环）SC201（1900A）
SC203	第三代（步进开环）SC203（1906A）
AS201	第四代（步进闭环）ASC201（1900A）
AS203	第四代（步进闭环）ASC203（1906A）
MS201	第五代（步进开环）MSC201（1900A）
MS203	第五代（步进开环）MSC203（1906A）
MA201	第五代（步进闭环）MASC201（1900A）
MA203	第五代（步进闭环）MASC203（1906A）

对应其余的第 2~4 项显示的软件版本详细信息，也是按照上面描述的方法来解释。

### 3.5 查看运行总针数和清除加润滑油报警信息

当机器运行一段时间后，可能会出现报 E221“补充润滑油告警异常”，表示需要补充润滑油。

在此种情况下，可以上电后先开启服务参数，然后按 、 键将面板显示改为“2

45.--”，再按  键，缝制灯亮起进入软件版本显示机器已经运转的总针数。通过按  键

可以切换显示“万针”单位和“一针”单位，花样号 LED 点亮时数码管显示的是万针单位以下的针数即“一针”，计数器 LED 点亮时数码管显示的是万针数即“万针”。而机器实际运行的总针数可以表述为 10000 X “万针” + “一针”。当对机器补充好润滑油以后，在

此界面下，按  键清除已经运行的总针数，机器就可以继续正常使用了。（注：如果只想

查看机器运转的总针数而不需要清除，按  退出回到参数设置模式即可）

## 4 钉扣功能

### 4.1 钉扣功能设定

- 1、在缝制灯熄灭的状态下，按 **(M)** 键，显示 **130**，然后 **(P1)** **(P3)** **(P5)** 同时按键，听到蜂鸣器响声后，即开启了服务参数变更；
- 2、按 **(+/C<sup>+</sup>)**、**(-/C<sup>-</sup>)** 键，选择 241 号参数：

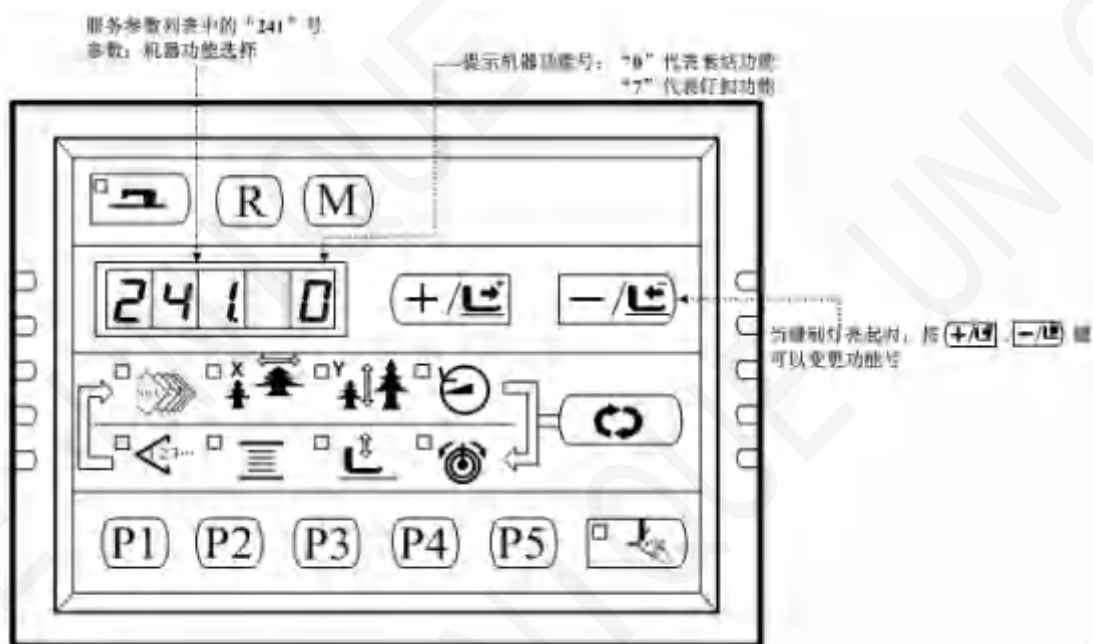

- 3、按 **(R)** 键，缝制灯亮起，然后按 **(+/C<sup>+</sup>)**、**(-/C<sup>-</sup>)** 键，将功能号变更为“7”；再次按 **(R)** 键确认功能号，缝制灯灭。
- 4、按 **(M)** 键，退出服务参数设置模式，返回到普通缝制模式；断电并再次上电后，机器功能变更为钉扣功能。

**注意：**机器的钉扣功能需要钉扣所需的专用压脚等辅助外设，有关这方面的详细信息请您与您的机械供应商或代理商联系。

## 5 通过 U 盘升级花样

### 5.1 花样升级操作

可支持 VDT 花样的单个导入(追加):

62=1: 导入(追加)花样, 如果导入的花样号已经存在则进行覆盖;

62=2: 导出所有外置花样到 USB 存储设备;



62=3: 清除(格式化)面板外置花样存储区域;



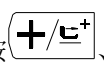

#### 花样升级操作:

电控可以使用 U 盘将 VDT 格式的花样输入到系统中, 升级后的花样编号为 101~200。也可以将电控中 101~200 号已经存在的花样导出到 U 盘中。(注: 第五代电控将不再支持 BIN 格式花样)

- 1、使用花样编辑软件制作 VDT 格式的花样文件, 并命名为“XXX.VDT”(注: XXX 必需为 101~200 的花样号码, 同时该号码也是升级后的花样号)。
- 2、在 U 盘根目录下建立一个名为 DH 的文件夹, 将步骤 1 中制作好的花样保存到 U 盘中的这个 DH 目录下, 一次可以导入多个花样文件。

- 3、在缝制灯熄灭的状态下, 按  键, 显示 , 然后同时按键, 听到蜂鸣器响声后, 即开启了服务参数变更;

- 4、按 、 键, 选择 62 号参数, 并将存入花样的 U 盘插入到面板右侧的 USB 接口上。

- 5、按  键, 缝制灯亮起, 然后按 、 键, 将功能号变更为“1”; 再次按  键确认功能号:

**注意:** 在此步骤操作之前, 请确认已经先将 U 盘插入面板 USB 接口, 如若未插入 U 盘而执行该步骤操作, 则无法进行升级操作, 面板会提示 E512 “操作头读写 USB 存储设备异常” 错误。

- 6、面板会提示“USB——”, 表示正在进行花样升级操作, 当升级完毕后, 面板自动跳转会参数界面, 显示变为“62.0”, 表示花样升级完成。
- 7、在升级完成后, 如果升级前电控中已经存在 101~200 号某些已经导入的花样, 电控会将这些花样备份到 U 盘中的 DH 目录中, 备份的花样文件以“BAK\_XXX.VDT”的形式命名(注: XXX 即为电控中已经存在的 101~200 花样编号)。

**注意:** 如果电控中已经存在 101~200 号升级的某些花样, 也可以通过在 U 盘中存入命名编号与电控中已存在花样不同的花样文件, 并按照上述操作进行花样追加; 如果 U 盘中存入命名编号与电控中已存在花样相同的花样文件, 则进行升级操作后, 电控中那些编号相同的花样将被替换。

另外, 在第 5 步中, 除了将功能号改为 1 进行花样升级导入操作外, 还可以将功能号改为 2 和 3, 分别进行花样的导出和删除操作。改为 2 时的功能实际上相当于手动执行步骤 7 中的花样备份操作, 而改为 3 时的功能是将所有 101~200 号花样全部删除清空, 当电控出现报 E506 “操作头外置花样存储空间已满” 或 E507 “操作头外置花样存储区域

格式异常”错误时，可以尝试此删除操作。

- 8、打开花样锁：花样升级完毕后，在缝制界面如果选择花样号时，如果不能选中新升级的 U 盘花样，可能是因为没有将花样锁打开，101~200 号花样出厂默认时是锁定不能选择的，需要进行如下操作：

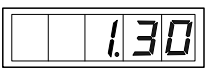
- 9、按 **(M)** 键，显示 ，然后按 **(+/c+)**、**(-/c-)** 键，选择参数号为“201”的用户参数。

用户参数列表中的“201”号参数：  
 查看是否可以读出图案数据

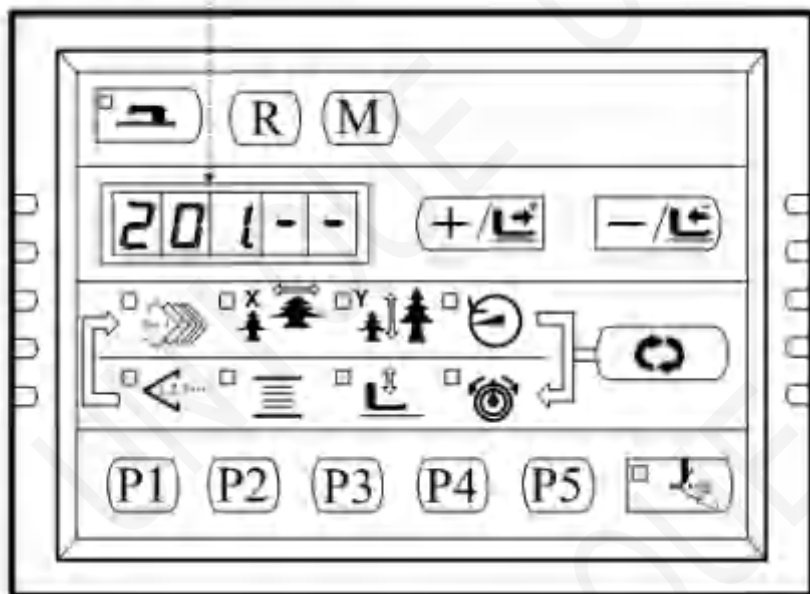

- 10、按  键，缝制灯亮起，进入花样开关模式，屏幕显示“1-1”：

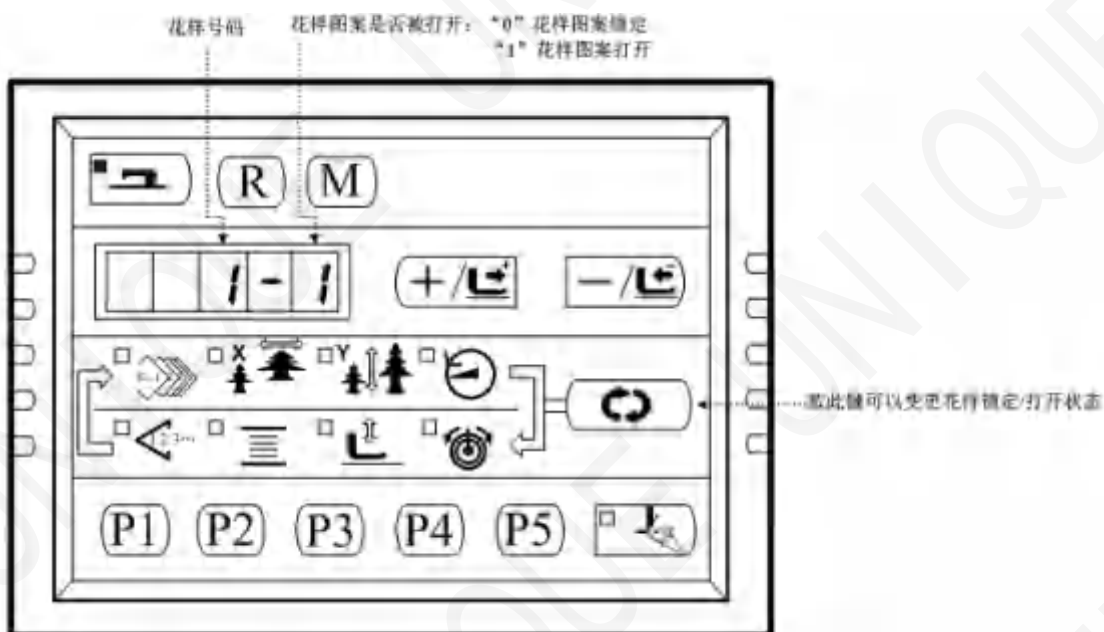

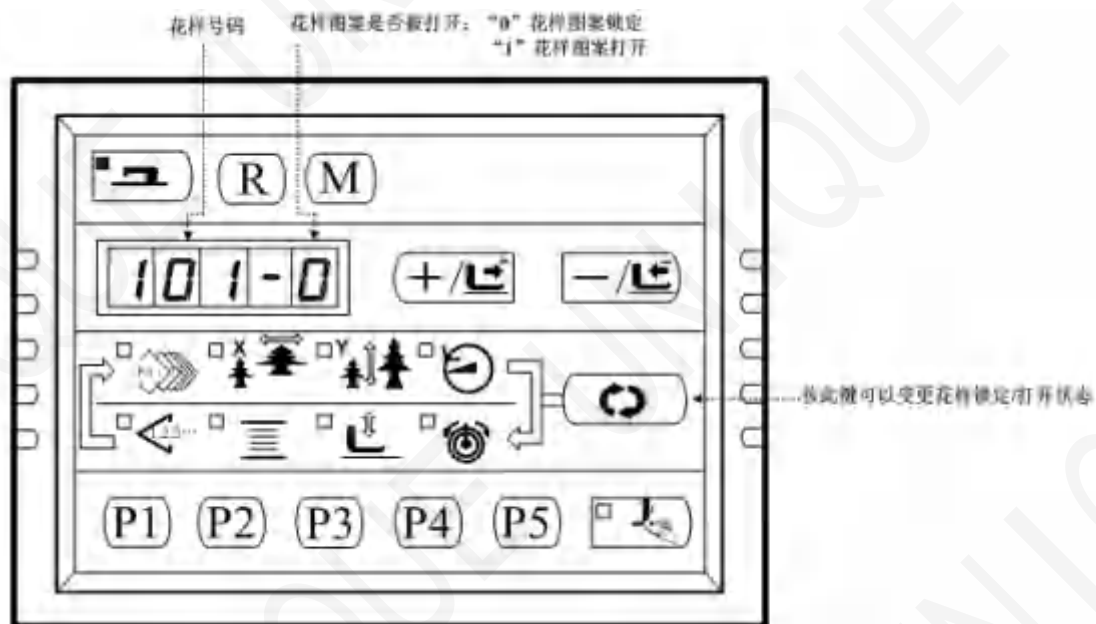

- 11、按 **(+/c+)**、**(-/c-)** 键，选择你想变更的花样号码（例如 101 号花样）：



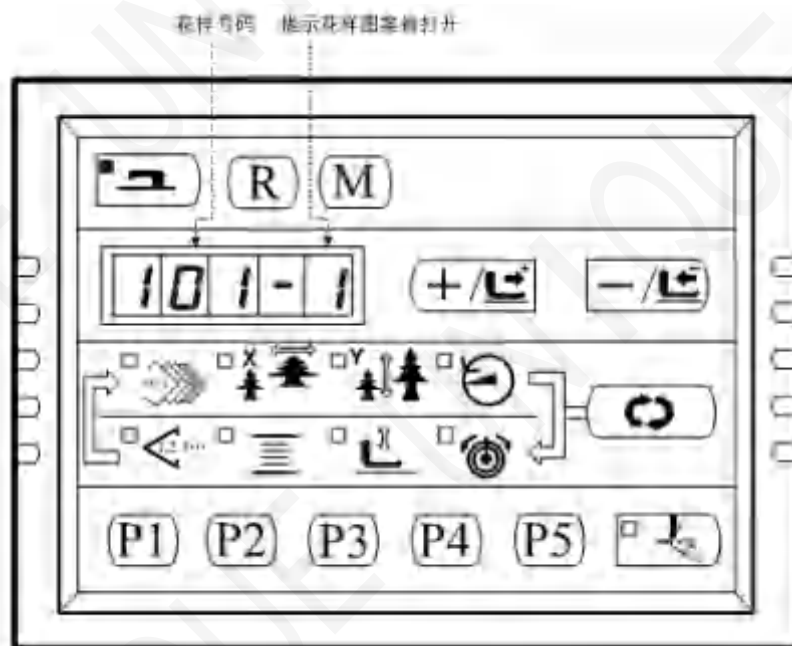

- 12、按  键，显示由“101-0”变更为“101-1”，即 101 号花样图案被打开：













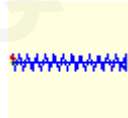
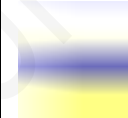



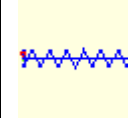

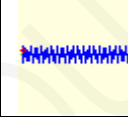

- 13、按  键，缝制灯熄灭，保存设置的参数，并退回到步骤 11 的界面；用户可以反复操作步骤 11-12，将所需的全部花样打开或者锁定。

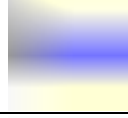
- 14、按  键，退回到正常缝制模式。



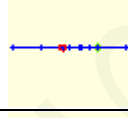

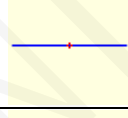
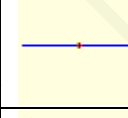
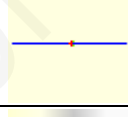
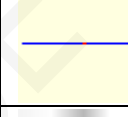









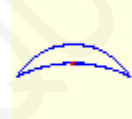
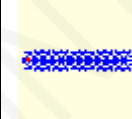

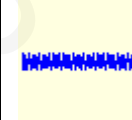
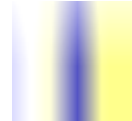
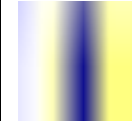
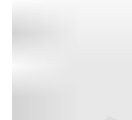



- 15、用  键选中花样号码图标（参照【2.4.1 项目数据的设定】），然后按 、 键，可以检索到解除锁定的 101 号花样图案，并开始缝制作业。

## 6 附录 1

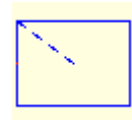
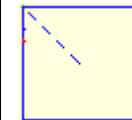
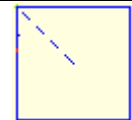
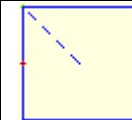
## 6.1 1900A 套结机花样一览表

NO.	缝纫图案	针数	长 × 宽 (mm)	NO.	缝纫图案	针数	长 × 宽 (mm)
1		41	16.1×2	2		41	10.2×2
3		41	16×2.4	4		41	24×3
5		27	10.1×2	6		27	16×2.4
7		35	10.1×2	8		35	16×2.4
9		55	24×3	10		63	24×3
11		20	6.1×2.4	12		27	6.2×2.4
13		35	6.1×2.4	14		14	8×2
15		20	8×2	16		27	8×2
17		20	10×0	18		27	10×0
19		27	25.2×0	20		35	24.8×0
21		40	25.2×0	22		43	35×0
23		27	4×20	24		35	4×20

25		41	4×20	26		55	4×20
27		17	0×20	28		20	0×10
29		20	0×20	30		27	0×20
31		51	10.1×7	32		62	12.1×7
33		23	10.2×6	34		30	12×6
35		47	7×10	36		47	7×10
37		89	24×3	38		27	8×2
39		25	11.8×12	40		45	12×12
41		28	2.4×20	42		38	2.4×25
43		38	2.4×25	44		57	2.4×30
45		75	2.4×30	46		41	2.4×30
47		89	8×8	48		98	8×8
49		147	8×8	50		163	8×8
51		110	7.9×7.9	52		120	7.9×7.9

53		130	7.9×7.9	54		51	12.4×10.2
55		50	12.4×10.2	56		52	21×6
57		57	21×6	58		102	19×3
59		115	40×5	60		115	40×5
61		93	5×30	62		109	5×30
63		108	40×30	64		80	40×30
65		64	40×30	66		96	30×30
67		76	30×30	68		60	30×30
69		52	40×30	70		40	40×30
71		32	40×30	72		44	30×30
73		36	30×30	74		28	30×30
75		60	40×30	76		48	40×30
77		36	40×30	78		56	30×30
79		44	30×30	80		36	30×30

81		67	40×30	82		51	40×30
83		39	40×30	84		55	30×30
85		35	30×30	86		42	30×30
87		32	30.1×30	88		26	30×30
89		74	20×24	90		54	20×24
91		65	20×20	92		49	20×20
93		39	20×20	94		63	25×20
95		51	25×20	96		45	25×20
97		42	25×20	98		33	25×20
99		27	25×20	100		88	30×25













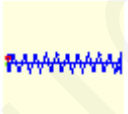
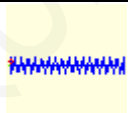
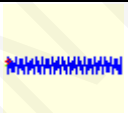



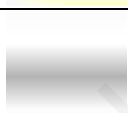

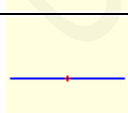
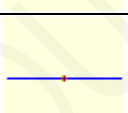
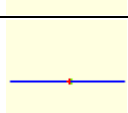
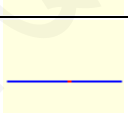

6.2 钉扣机花样一览表





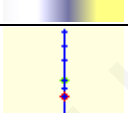

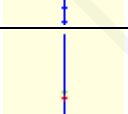
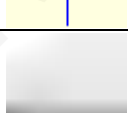







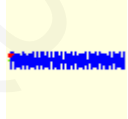



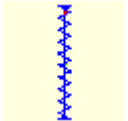
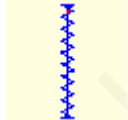
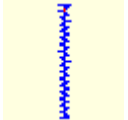

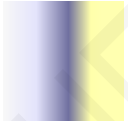

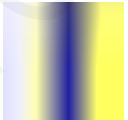
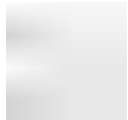

图案号	缝制图案	缝线(根)	标准缝制长度 X(mm)	标准缝制长度 Y(mm)	图案号	缝制图案	缝线(根)	标准缝制长度 X(mm)	标准缝制长度 Y(mm)
1·34		6-6	3.4	3.4	18·44		6	3.4	0
2·35		8-8			19·45		8		
3		10-10			20		10		
4		12-12			21		12		







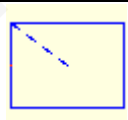



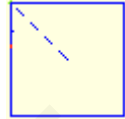
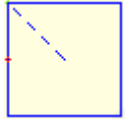



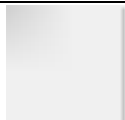
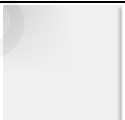
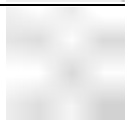
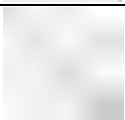





5 • 36		6-6			22		16		
6 • 37		8-8			23 • 46		6	0	3.4
7		10-10			24		10		
8		12-12			25		12		
9 • 38		6-6			26 • 47		6-6	3.4	3.4
10 • 39		8-8			27		10-10		
11		10-10			28 • 48		6-6		
12 • 40		6-6			29		10-10		
13 • 41		8-8			30 • 49		5-5-5	3.0	2.5
14		10-10			31		8-8-8		
15 • 42		6-6			32 • 50		5-5-5		
16 • 43		8-8			33		8-8-8		
17		10-10							





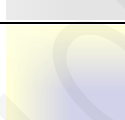
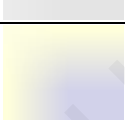

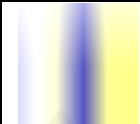
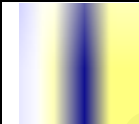

## 6.3 1906A 套结花样一览表

NO.	缝纫图案	针数	长 × 宽 (mm)	NO.	缝纫图案	针数	长 × 宽 (mm)
1		41	16.1 × 2	2		41	10.2 × 2
3		41	16 × 2.4	4		41	24 × 3

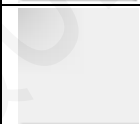
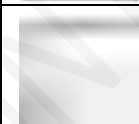
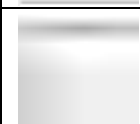
5		27	10.1×2	6		27	16×2.4
7		35	10.1×2	8		35	16×2.4
9		55	24×3	10		63	24×3
11		20	6.1×2.4	12		27	6.2×2.4
13		35	6.1×2.4	14		14	8×2
15		20	8×2	16		27	8×2
17		20	10×0	18		27	10×0
19		27	25.2×0	20		35	24.8×0
21		40	25.2×0	22		43	35×0
23		27	4×20	24		35	4×20
25		41	4×20	26		55	4×20
27		17	0×20	28		20	0×10
29		20	0×20	30		27	0×20
31		51	10.1×7	32		62	12.1×7

33		23	10.2×6	34		30	12×6
35		47	7×10	36		47	7×10
37		89	24×3	38		27	8×2
39		25	11.8×12	40		45	12×12
41		28	2.4×20	42		38	2.4×25
43		38	2.4×25	44		57	2.4×30
45		141	10×30	46		122	10×30
47		97	10×30	48		109	10.1×30
49		122	10.1×30	50		265	10×30
51		108	40×30	52		80	40×30
53		64	40×30	54		96	30×30
55		76	30×30	56		60	30×30
57		52	40×30	58		40	40×30
59		32	40×30	60		44	30×30

61		36	30×30	62		28	30×30
63		60	40×30	64		48	40×30
65		36	40×30	66		56	30×30
67		44	30×30	68		36	30×30
69		67	40×30	70		51	40×30
71		39	40×30	72		55	30×30
73		43	30×30	74		35	30×30
75		42	30×30	76		32	30.1×30
77		26	30×30	78		103	30×25
79		82	30×25	80		64	30×25
81		80	20×30	82		60	20×30
83		80	30×20	84		60	30×20
85		74	20×24	86		54	20×24
87		115	40×5	88		115	40×5

89		93	5×30		90		109	5×30
91		65	20×20		92		49	20×20
93		39	20×20		94		63	25×20
95		51	25×20		96		45	25×20
97		42	25×20		98		33	25×20
99		111	60×40		100		91	60×40

#### 6.4 异常信息一览表

错误代码	异常名称	异常内容	原因及解除方法
E7	机器锁定	因为发生了某些故障，缝纫机主轴不能转动。	发送主轴运转命令后，主轴电机无反映。查看主轴电机驱动电路六路 PWM 波形是否正常，编码器反馈信号是否正常，也可能是机械卡死所造成。
E10	图案 NO. 异常	被准备的图案 NO. 没有登记到 ROM 里，或是被设定为不能读出。图案 NO. 为 0。	按复位开关，确认图案 NO.。确认存储器开关 NO.201 的内容。
E30	针杆上位置异常	针杆不在上位置。	主轴停车位置错误，可能是主轴驱动的原因，也可能是人为转动所致。转动手轮，把针杆返回到上位置。
E40	超过缝制区域	超过缝制区域。	按复位开关，确认图案和 X、Y 放大率。 触发条件：软件花样计算报错。

E43	超过缝制区域	超过缝制区域。	按复位开关，确认图案和 X、Y 放大率。 触发条件：软件花样计算报错。
E50	暂停	缝纫机运转中按了复位开关，暂停。	按复位开关切线后，再次开始或返回原点。
E221	补充润滑油告警异常	机器运转到了向指定位置补充润滑油的时期，所以缝纫机停止了。	重新上电，进入参数 245，按复位键清零后，重现上电。
E302	机头翻倒异常	机头翻倒检测开关被设定为 ON。	在放倒机头的状态不能运转。请返回到正常的位置。技术人员可直接用短路块将机头板上的 2P 蓝色插头短路。
E303	24V 电源异常	24V 电压过低。	关闭电源，稍待一些时间后再次打开电源。
E305	压脚位置异常	压脚不在正确位置。	关闭电源开关，确认机头信号电路板上的 CZ025 是否松动脱落。若未松动，检查该路光藕。
E306	抓线位置异常	抓线装置不在正确位置。	关闭电源开关，确认机头信号电路板上的 CZ026 是否松动脱落。若未松动，检查该路光藕。
E307	切线切刀位置异常	切线刀不在正确位置。	关闭电源开关，确认机头信号电路板上的 CZ024 是否松动脱落。若未松动，检查该路光藕。
E500	操作头花样参数为空	操作头读取 EEPROM 中的花样参数为空。	
E501	操作头内存参数范围异常	操作头读取 EEPROM 中内存参数范围异常	按复位键后自动进入 67 号参数，进行恢复出厂设置操作。
E502	面板读取下位机参数范围异常	操作头接收到下位机发送的机头板参数范围异常。	按复位键后自动进入 67 号参数，进行恢复出厂设置操作。
E503	操作头花样参数异常	操作头使用花样参数时发现花样参数不存在。	

E504	操作头花样参数范围异常	操作头使用花样参数时发现花样参数范围异常。	按复位键后自动进入 67 号参数，进行恢复出厂设置操作。
E505	操作头花样数据格式异常	操作头读取花样缝纫数据时发现标志数据格式异常。	选择其他号码的花样。
E506	操作头外置花样存储空间已满	在导入 USB 花样时检测到操作头存储外置花样数据的存储器空间已满。	使用 62 号参数将现有内置花样导出后，格式化存储区域后再进行花样导入操作。
E507	操作头外置花样存储区域格式异常	操作头读取外置花样数据格式信息时发现标志数据异常。	使用 62 参数格式化存储区域。
E508	操作头导入 USB 花样已存在	在导入 USB 花样时检测到操作头中已经有相同号码的外置花样。	将 USB 存储设备中要导入的花样名更改为未使用的号码再进行升级。
E509	操作头导入 USB 花样未找到	在导入 USB 花样时在 USB 存储设备上没有找到要导入花样号的花样文件。	选择在 USB 存储设备上已存在花样号的花样文件进行导入。
E510	操作头删除外置花样错误	在删除操作头外置花样时检测到要删除花样号的花样数据不存在。	选择已经存在花样号的花样数据进行删除。
E511	操作头读取外置花样错误	操作头在从外置花样数据存储区域读取花样数据时出现异常。	选择其他号码的花样。
E512	操作头读写 USB 存储设备异常	在进行花样导入、导出操作时操作头检测到读写 USB 存储设备异常。	更换 USB 存储设备进行操作。
E513	机型参数异常	操作头上电读取机型参数值不在已定义的机型范围以内。	按复位键后自动进入 241 号参数，选择已定义的机型后保存参数。
E515	主控固件程序校验错误	通过 USB 更新主控固件程序前固件文件校验失败。	检查主控固件程序文件 mControl 是否正确放置到 U 盘 update 目录下，且文件内容正确。
E516	主控固件程序升级失败	通过 USB 更新主控固件程序过程中出现错误导致升级失败。	检查主控固件程序文件内容是否正确并重新进行升级操作。

E517	面板固件程序未找到	通过 USB 更新面板固件程序前未在 U 盘中检索到升级文件。	检查面板固件程序文件 Kdpanel 是否正确放置到 U 盘 update 目录下。
E518	面板固件程序校验错误	通过 USB 更新面板固件程序前校验升级文件内容失败。	检查面板固件程序文件 Kdpanel 是否正确放置到 U 盘 update 目录下，且文件内容合法。
E519	面板固件程序升级失败	通过 USB 更新面板固件程序过程中出现错误导致升级失败。	检查面板固件程序文件内容是否正确并重新进行升级操作。
E600	脚踏板未在中央位置	在进入准备缝制状态过程中脚踏板被踩下。	确认进入准备缝制界面时脚踏板没有被踩下。
E601	气阀（风扇）故障	开机后系统检测到气阀或风扇电压信号异常。	关机，检查外设有无短路情况。
E602	电机运行异常	主轴电机在运行过程中到达 0° 时电气角度范围异常。	关机。查看电机编码器信号是否正常。
E603	急停开关未在正常位置	启动之前检测到急停开环被按下。	自恢复错误。
E604	机器老化停止	在老化模式下机器进入了停止状态。	关机。
E680	步进闭环 DSP1 (X25/X27) 通信错误	步进对接收到的指令进行校验未通过。	查看 SPI 通信线缆连接是否正确、牢固。
E681	步进闭环 DSP1 第一路 (X27) 过流	硬件检测到有大电流出现。	首先检查电机是否正常，可测量电阻、电感值是否在正常范围内。如果电机正常，则需确认步进板硬件是否正常。
E682	步进闭环 DSP1 第一路 (X27) 超差	检测到的编码器反馈位置与程序中的指令位置不符。	将步进电机改成开环模式运行，如果可以正常动作，则电机正常。如果电机不能正常动作，则需要排查步进板驱动部分及电机本体。做完上述工作后，排查编码器部分，看编码器线缆是否插错，是否插牢，是否有编码器信号线损坏以及步进板信号反馈部分及编码器本体是否正常。

E683	步进闭环 DSP1 第一路(X27)超速	通过编码器反馈信号检测到电机转速异常时报此错误。	检查方法同检查超差错误。
E685	步进闭环 DSP1 第二路(X25)过流	硬件检测到有大电流出现。	首先检查电机是否正常,可测量电阻、电感值是否在正常范围内。如果电机正常,则需确认步进板硬件是否正常。
E686	步进闭环 DSP1 第二路(X25)超差	检测到的编码器反馈位置与程序中的指令位置不符。	将步进电机改成开环模式运行,如果可以正常动作,则电机正常。如果电机不能正常动作,则需要排查步进板驱动部分及电机本体。做完上述工作后,排查编码器部分,看编码器线缆是否插错,是否插牢,是否有编码器信号线损坏以及步进板信号反馈部分及编码器本体是否正常。
E687	步进闭环 DSP1 第二路(X25)超速	通过编码器反馈信号检测到电机转速异常时报此错误。	检查方法同检查超差错误。
E690	步进闭环 DSP2(X21/X23)通信错误	步进对接收到的指令进行校验未通过。	查看 SPI 通信线缆连接是否正确、牢固。
E691	步进闭环 DSP2 第一路(X23)过流	硬件检测到有大电流出现。	首先检查电机是否正常,可测量电阻、电感值是否在正常范围内。如果电机正常,则需确认步进板硬件是否正常。
E692	步进闭环 DSP2 第一路(X23)超差	检测到的编码器反馈位置与程序中的指令位置不符。	将步进电机改成开环模式运行,如果可以正常动作,则电机正常。如果电机不能正常动作,则需要排查步进板驱动部分及电机本体。做完上述工作后,排查编码器部分,看编码器线缆是否插错,是否插牢,是否有编码器信号线损坏以及步进板信号反馈部分及编码器本体是否正常。
E693	步进闭环 DSP2 第一路(X23)超速	通过编码器反馈信号检测到电机转速异常	检查方法同检查超差错误。

		时报此错误。	
E695	步进闭环 DSP2 第二路(X21)过流	硬件检测到有大电流出现。	首先检查电机是否正常,可测量电阻、电感值是否在正常范围内。如果电机正常,则需确认步进板硬件是否正常。
E696	步进闭环 DSP2 第二路(X21)超差	检测到的编码器反馈位置与程序中的指令位置不符。	将步进电机改成开环模式运行,如果可以正常动作,则电机正常。如果电机不能正常动作,则需要排查步进板驱动部分及电机本体。做完上述工作后,排查编码器部分,看编码器线缆是否插错,是否插牢,是否有编码器信号线损坏以及步进板信号反馈部分及编码器本体是否正常。
E697	步进闭环 DSP2 第二路(X21)超速	通过编码器反馈信号检测到电机转速异常时报此错误。	检查方法同检查超差错误。
E730	编码器未接	不能检测 ADTC 信号。	关闭电源开关,确认 X5 插头是否插紧。
E733	主轴过流	马达停转。	在机械不卡的情况下,检查主轴编码器是否连接良好。
E735	停车电流异常	主轴停车过程中出现过流。	关闭电源,稍待一些时间后再次打开电源。更换主轴电机确认电机是否损坏;如果问题不能解决,请更换主板。
E736	主板 IPM 瞬时过流	主板 IPM 驱动模块短时间内电流过大。	关闭电源,稍待一些时间后再次打开电源。更换主轴电机确认电机是否损坏;如果问题不能解决,请更换主板。
E737	主板 IPM 多次过流	主板 IPM 驱动模块在上电后累计多次出现过流。	关闭电源,稍待一些时间后再次打开电源。更换主轴电机确认电机是否损坏;如果问题不能解决,请更换主板。
E740	主轴超速	在机器运转过程中检测到主轴电机实际转	关闭电源,稍待一些时间后再次打开电源。

		速超过限定最大值。	
E811	电压过高异常	电源电压超过规定值。	检测到 AC_OVDT 信号为高, 确认电源电压及相关电路。
E813	电压过低异常	电源电压不足。	采样 UZKIN 模拟量过低, 确认电源电压及相关电路。
E901	主轴驱动器不良	主轴驱动器检测出异常。	关闭电源, 稍待一些时间后再次打开电源。
E902	步进板 90V 电源异常	步进板 90V 短路。	关闭电源, 稍待一些时间后再次打开电源。
E903	步进驱动异常	步进驱动板过流。	关闭电源, 稍待一些时间后再次打开电源。
E904	24V 电源异常	24V 过流	关闭电源, 稍待一些时间后再次打开电源。
E907	X 原点检索异常	X 原点传感器不变化。	关闭电源开关, 确认机头信号电路板 CZ021、控制箱 X9 是否松动、脱落。
E908	Y 原点检索异常	Y 原点传感器不变化。	关闭电源开关, 确认机头信号电路板 CZ022、控制箱 X9 是否松动、脱落。
E909	剪线电机原点检索异常	剪线原点传感器不变化。	关闭电源开关, 确认机头信号电路板 CZ026、控制箱 X9 是否松动、脱落。
E910	压脚原点检索异常	压脚原点传感器不变化。	关闭电源开关, 确认机头信号电路板 CZ025、控制箱 X9 是否松动、脱落。
E913	抓线原点检索异常	抓线原点传感器不变化。	关闭电源开关, 确认机头信号电路板 CZ026、控制箱 X9 是否松动、脱落。
E915	主电路板-操作面板通信异常	主电路板与操作面板不能通信或通讯错误。	关闭电源, 稍待一些时间后再次打开电源。检查通讯线缆及主板与操作面板是否有故障。
E916	主电路板-步进电路板通信异常	主电路板与步进电路板不能通信或通讯错误。	关闭电源, 稍待一些时间后再次打开电源。检查通讯线缆及主板与驱动板是否有故障。
E920	步进软件版本错误	步进板软件版本错误。	更换套结机使用的步进板或更新步进办程序。

E943	下位机机头板参数异常	下位机从机头板读取参数异常。	确认机头板是否完好，X9 线缆是否插好。 可以通过按复位键使用 67 号参数尝试对机头板参数进行恢复操作。
E946	操作头电路板 EEPROM 读写错误	操作头电路板不能正常读写 EEPROM。	关闭电源，稍待一些时间后再次打开电源。
E999	未定义错误	下位机报出的错误代码操作头不能正确识别。	关机，更新操作头程序。

## 7 附录 2

### 7.1 电控箱安装尺寸

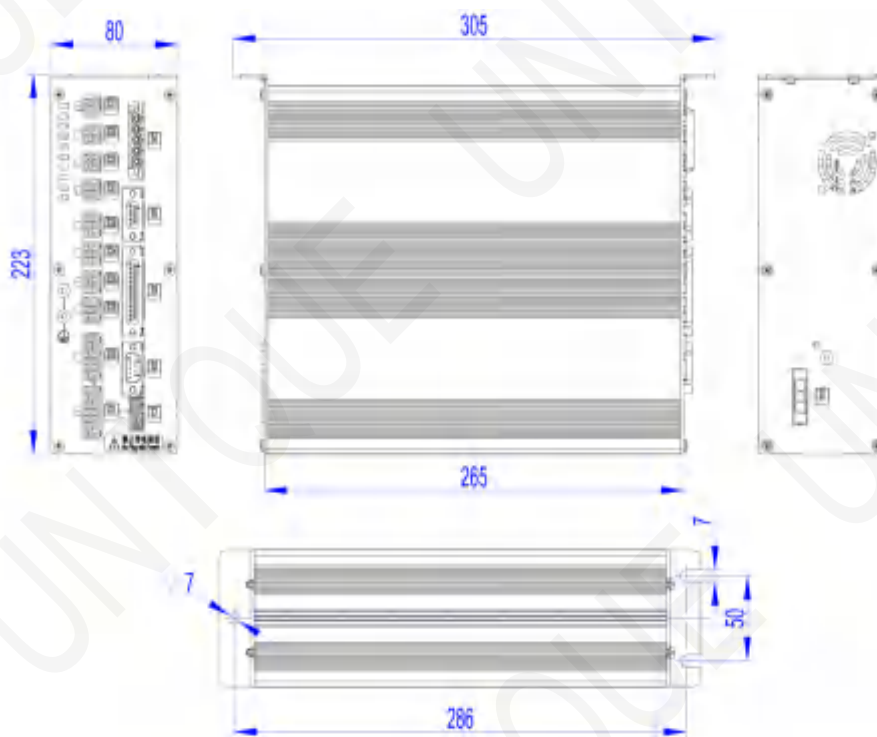

### 7.2 操作箱安装尺寸



图 4 操作箱安装尺寸图

### 7.3 控制箱外部线缆连接

#### 1、MSC201 电控箱后板接线图

注：外部线缆插头上有对应的编号，请仔细查看后对应接插，参照示意图 5。

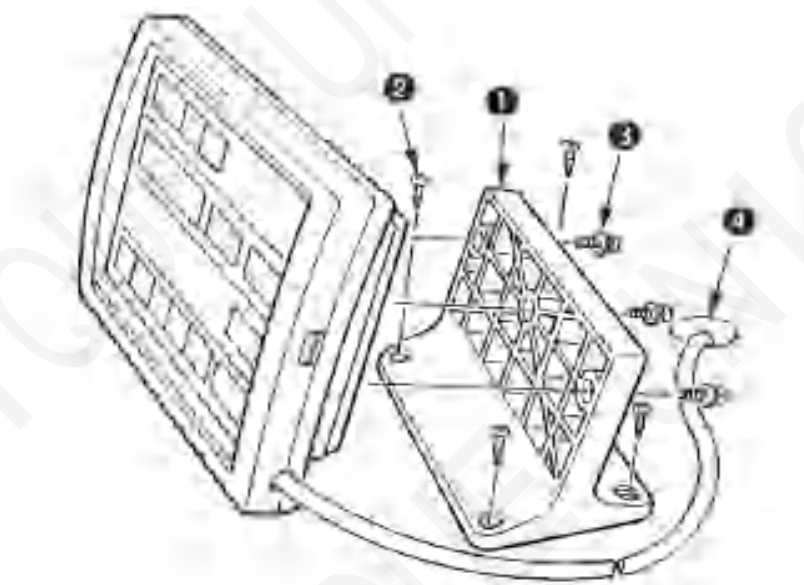
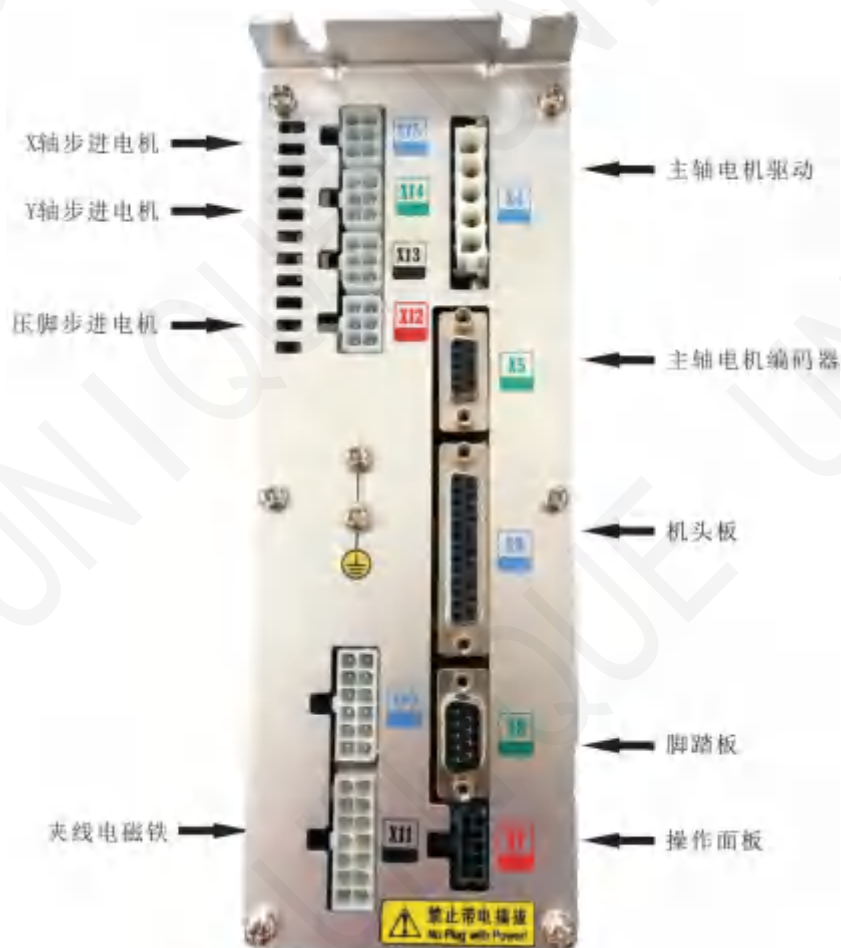

### 2、MASC201 电控箱后板接线图



### 7.4 系统框图

#### 1、MSC201/2D/A 系统框图

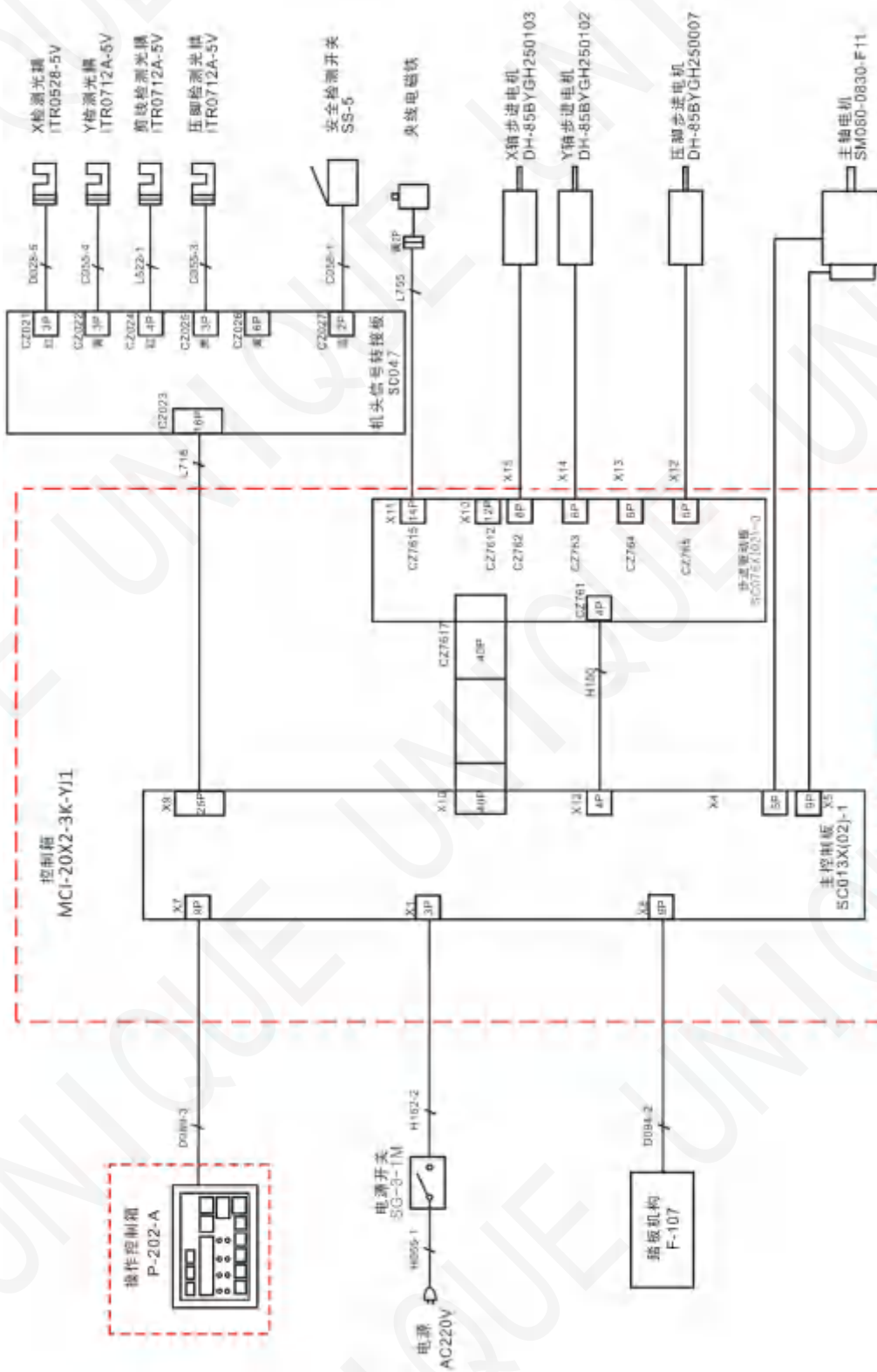

2、MASC201/2D/A 系统框图

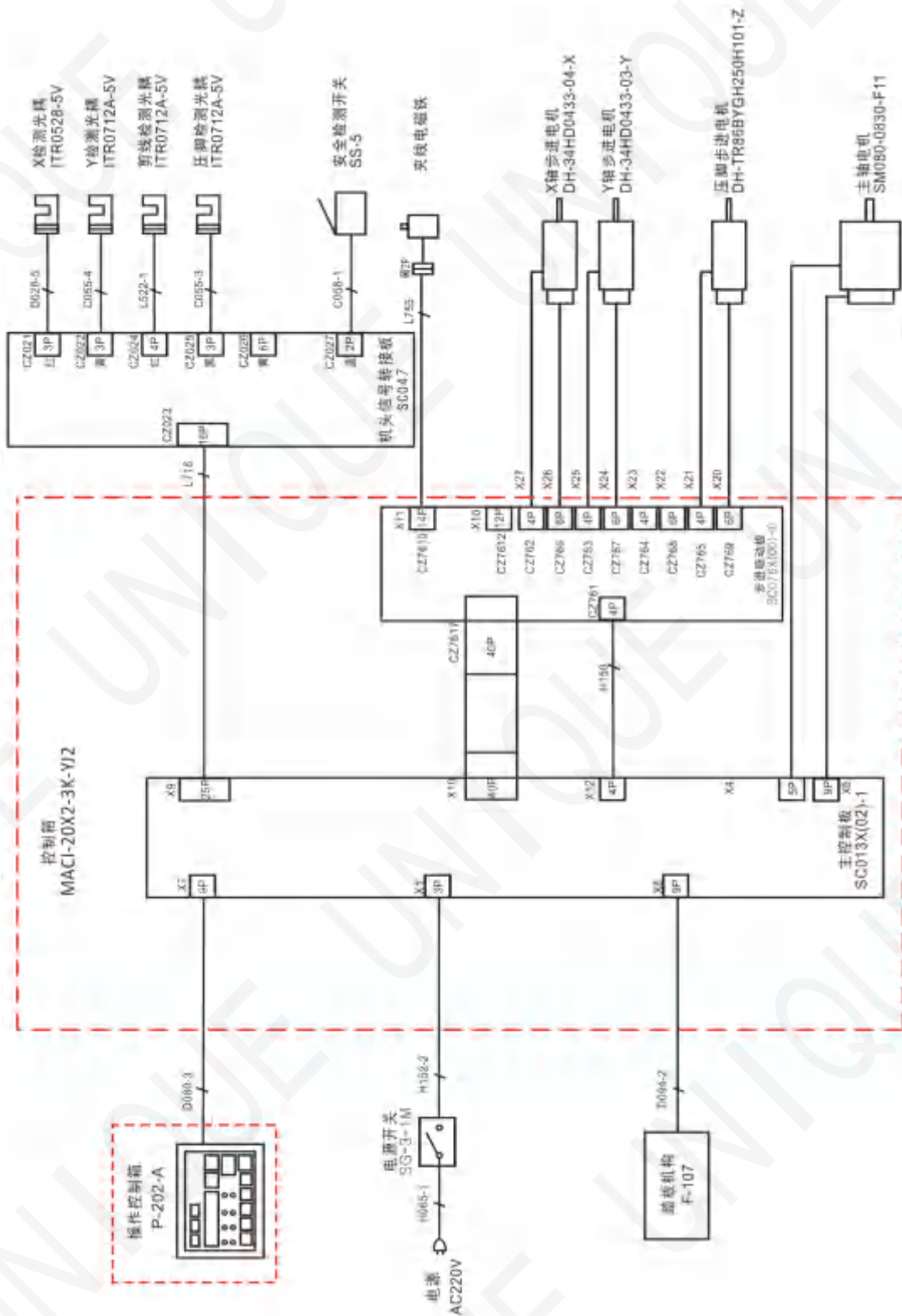

## 1. General Instruction

### 1.1 Specifications of 20X

No.	TYPE ITEM	20X
1	Purpose	Bartacking / Button Lockstitch
2	Sewing Area	X(lateral) direction 40mm × Y(longitudinal) direction 30mm
3	MAX. Sewing Speed	3000rpm (when sewing pitches are less than 4.5mm in X-direction and 3.5mm Y-direction)
4	Stitch Length	0.1mm – 10.0mm (adjustable in 0.1mm step)
5	Feed Motion of Work Clamp Foot	Intermittent Feed(2-draft drive by stepping motor)
6	Needle Bar Stroke	41.2mm
7	Needle	DP×5, DP×17
8	Type of driving Work Clamp Foot	Driven by pulse stepping motor
9	Lift of Work Clamp Foot	13mm (Standard), Max. 17mm
10	Total Number of Standard Patterns	50
11	Wiper Type	To work together with Work Clamp Foot driven by Stepping Motor
12	Thread Clamp	Standard : 0
13	Needle Thread Tension	Electrical Thread Tension Release
14	Shuttle	Standard Semi-rotary Hook (oil wick lubrication)
15	Lubricating Method	Rotary Part: Lubricate with minimum amount
16	Lubricating Oil (Liquid)	Ordinary Sewing Machine Lubricating Oil (Liquid)
17	Grease	Ordinary Sewing Machine Grease
18	Data Recording	Flash Memory
19	Enlarging/Reducing Facility	20%~200%(1% step) in X direction and Y direction respectively
20	Enlarging/Reducing Method	By increasing/decreasing the stitch length
21	Max. Sewing Speed Limitation	400-3000rpm (100rpm step)
22	Pattern Selection	Specifying Pattern No. Type(1-200)
23	Bobbin Thread Counter	Up/Down Type (0 – 9999)
24	Sewing Machine	500W Compact AC Servomotor (Direct Drive)

	Motor	
25	Dimensions	263mm×153mm×212mm
26	Weight	10 Kg
27	Power Consumption	600W
28	Operation Temperature Range	0℃～45℃
29	Operation Humidity Range	35%～85% (No Dew Condensation)
30	Line Voltage	AC 220V ± 10%; 50/60Hz

※ Reduce the MAX. Sewing Speed in accordance with the sewing conditions.

※Effective standard for product:QCYXDK0004—2016 《Computerized Control System for Industrial Sewing Machine》.

## 1.2 Corresponding Machine Type

MSC201/MASC201 Bartacking Machine

## 1.3 Input Mode

Use keys to input.

## 1.4 Display Method

Use 8-bit segment LED Display Module and LEDs to display all the information.

## 1.5 Arrangement of the Panel

The quadrate Panel can be divided into two parts, the display part and the operation part. There are 5 8-bit segment LED Display Module and 9 LEDs on the display part, and 11 keys on the operation part. For details, refer to 【2.1 Instructions of the Panel】.

## 1.6 Standardization

The function keys use standard icons recognized by the globe. Image is an international language that can be understood by any nation.

## 1.7 Operation Mode

Function keys include READY key, RESET key, MODE key, SELECTION key, etc. See operation instruction for detailed operating methods

## 2. Operation Instruction

### 2.1 Instructions of the Panel

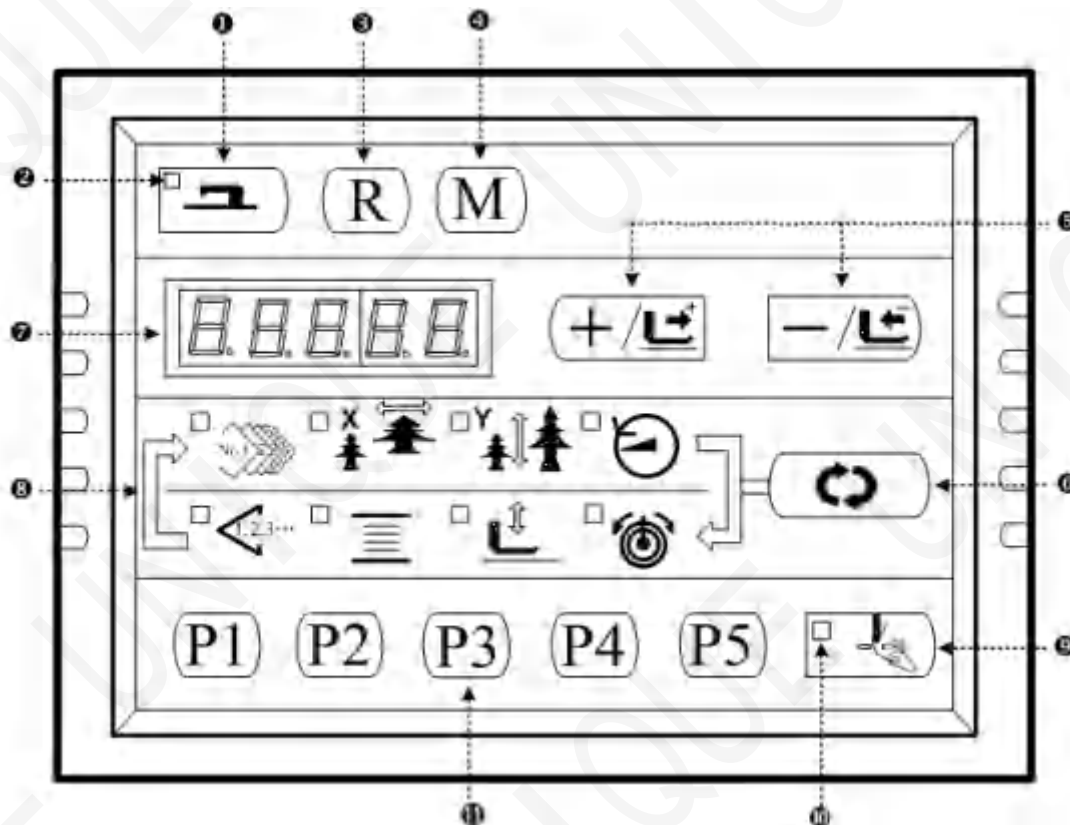

**❶ “Ready” key**

This key changes over the setting state from the panel to the sewing state where the sewing machine actually operates.

**❷ “Sewing LED”**

This LED goes off at the time of setting state and lights up at the time of sewing state. Change over can be performed with “Ready” key.

**❸ “Reset” key**

This key is used for canceling error or returning the set value to the initial value.

**❹ “Mode” key**

This key makes the setting mode of the memory switch.

**❺ “+ / Feed forward” key and “- / Feed backward” key**

This key is used for changing pattern NO. and X/Y scale, and feed forward / feed backward.

**❻ “Selection” key**

This key selects the item to be set. Item selection LED of the selected item and the set value are displayed.

**❼ Data indication LED**

This LED indicates the set values of the selected items such as pattern NO., X/Y scale, etc.

**❽ Item selection LED**

LEDs of the selected items light up.

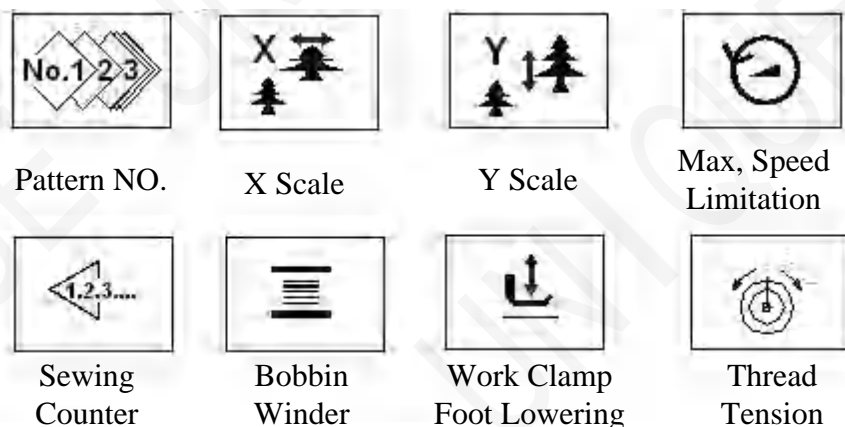

**⑨ Needle thread clamp ON/OFF key**

This key selects effective / ineffective of needle thread clamp. When it is effective, needle thread clamp display LED lights up.

**⑩ Needle thread clamp display LED**

When this LED lights up, needle thread clamp operates.

**⑪ Needle thread clamp display LED**

This key registers the pattern. When this key is pressed, the pattern registered here can sew immediately.

## 2.2 Installing the Main Motor

Assemble the main motor to the main shaft **①** through the coupling **②**. And you need 4 screws to fix the coupling to the main shaft and the main motor. Fix the coupling with No.1 Screw **⑥** and make sure that it is vertical towards the Flat Section, and then screw No.2 screw **③**. Fix the coupling to the main motor with No.3 screw **⑤**, and make sure it is vertical to the flat section of the main motor. Then screw the No.4 screw **④** to finish the assembling task. The following diagram shows you the details:

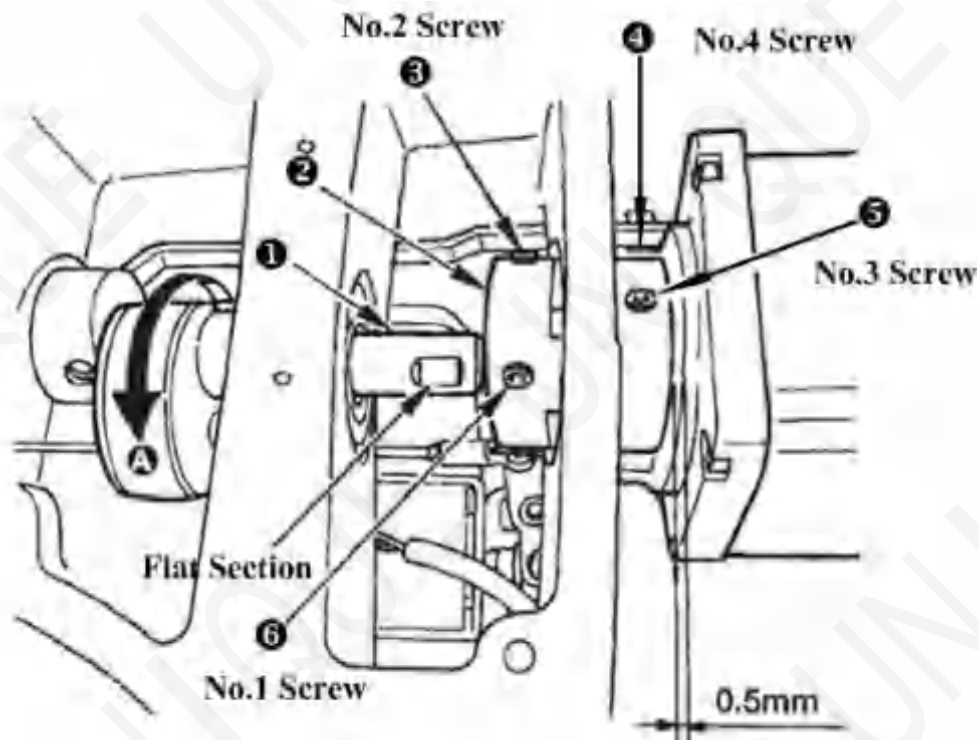

This following diagram shows you the position of the main motor (look from back, and the line is on your left-hand side):

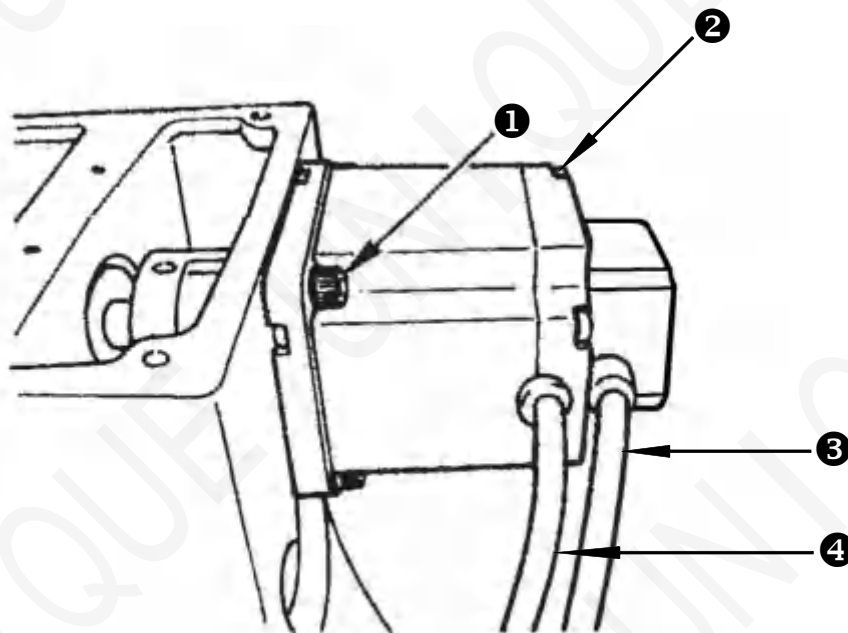







① Screws for fixing the main motor, totally 4; ② Screws for fixing the back of the motor, totally 4; ③ Sensor Cable; ④ Power cord.

## 2.3 Test Mode

This mode is set to facilitate the electrical check for maintenance work.

- 1) Press  key, while the Sewing LED is not illuminated, and then the Panel display

. Press    simultaneously, you would hear the ring of the buzzer, and then you are able to enter the test mode.

**Note: If you failed to press    simultaneously, then you cannot enter the test mode.**

- 2) Press  key to enter the test mode, and the screen displays “CP---”, as shown following:



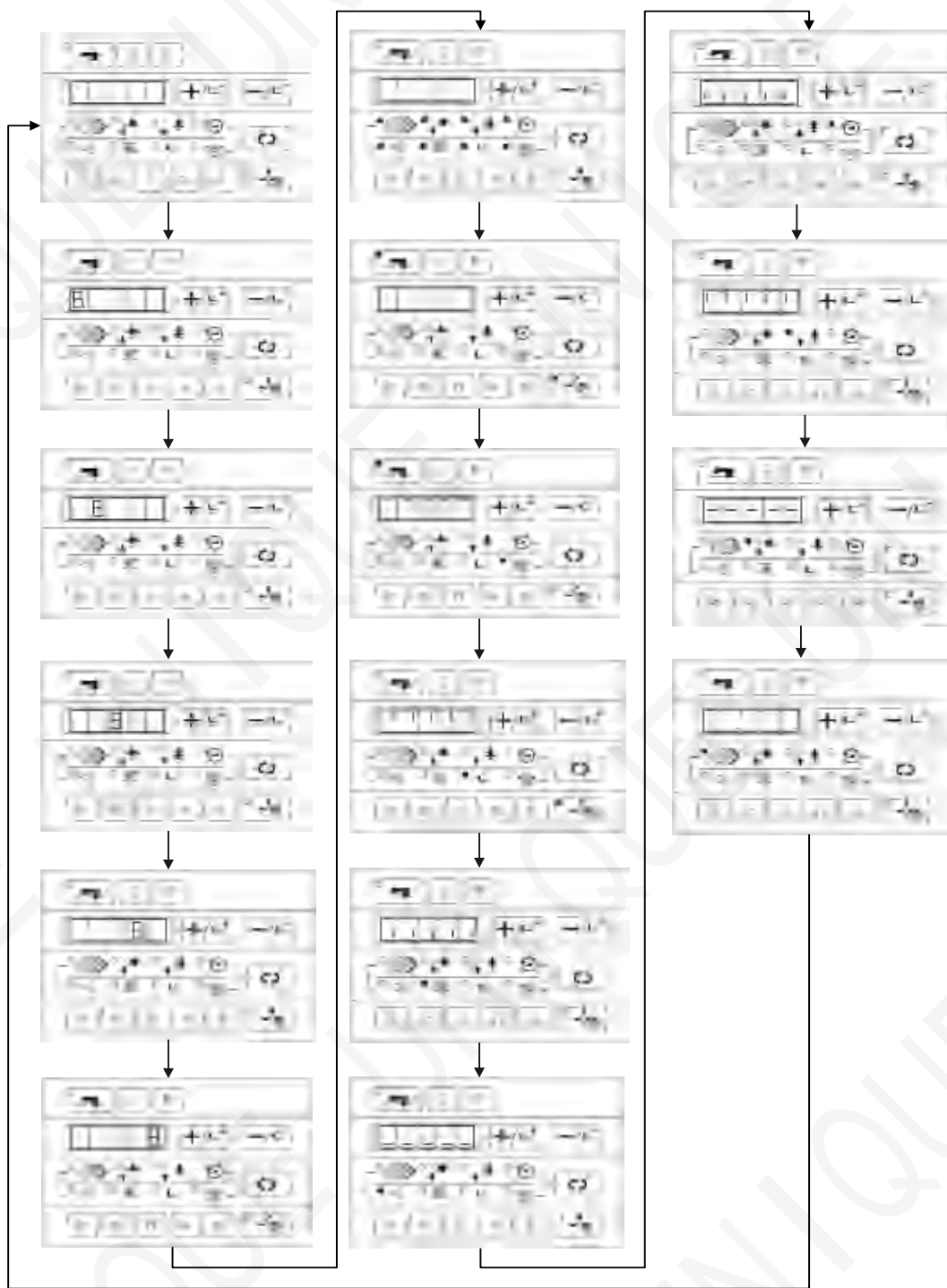

- 3) Press  key to start the Display Test. It automatically examine every 8-bit segment LED Display Module and the LED light illuminated or not, in a cycle process. The process is shown following:











4) Press  key again to end the Display Mode and the screen displays “CP-1”, as shown following:



**Note: You are not allowed to conduct other tests before the Display Mode Test.**

5) Press ,  key to change the Indication NO. For details, please refer to the list below:

Indication No.	Item	Description
	Input signal check	State of the switch and the sensor will be indicated by 9 LEDs.
	X/Y motor and Original Retrieval check	To indicate the X/Y motor step motion and original adjustment.
	Continuous operation	Initial setting of the operation conditions will be performed, and the mode will move to the continuous aging mode.
	Number of revolutions of main shaft check	Output of the specified number of revolutions will be made and the actual number of revolutions will be indicated.
	_____	_____
	Presser and Trimming Original Retrieval check	Indicate the presser/trimming motor to move step by step; indicate original retrieval and the state of presser/trimming sensor.
	Thread Clamp and Original check	Indicate the thread clamp motor to move step by step; indicate original retrieval and the state of thread clamp/origin sensor.

6) Press  key to check the items.

7) Press  to end up the test and return back to Step 5), however, if “CP-3” is selected, it is impossible to return to other test modes. Turn Off the power and turn On the power again in accordance with the starting way of the test mode.

### 2.3.1 CP-1 (Input Signal Check)

Status of input of switches and sensors is indicated on the 8 LEDs.

The table below is the list of LED indication, and you can understand to which LED each switch

or each sensor is assigned. When “CP-1” is indicated on the screen, press  key to enter into the mode and then number “1” is indicated.

Indicated No.  
Press P1 and P2 simultaneously and the No.  
will automatically add by 1

Indicate the status of item selection by  
LED ON/OFF. Refer to the table list.

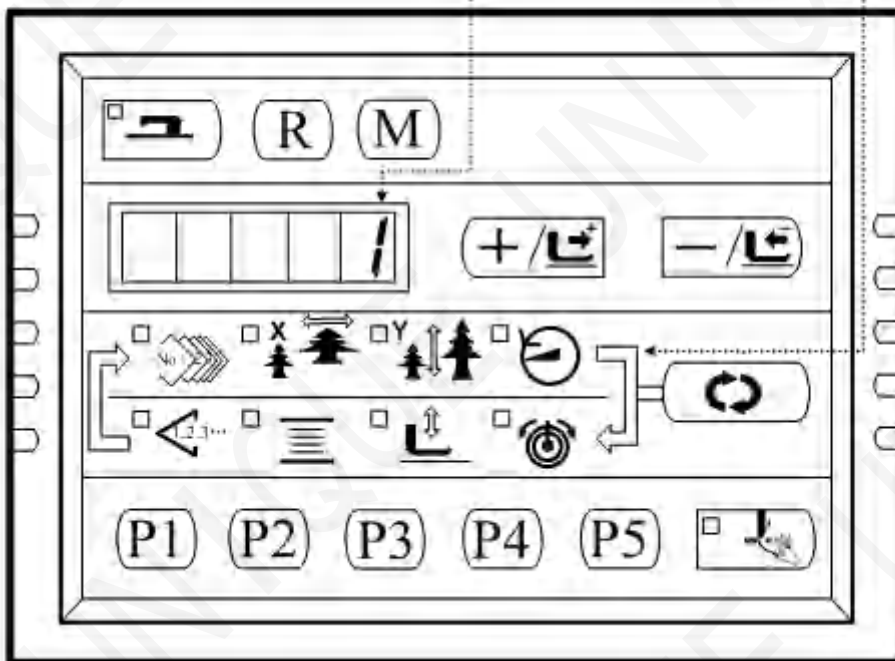

Indication of No.

Input No. <sup>1)</sup>	Pattern NO. LED <sup>2)</sup>	X Scale Rate LED <sup>3)</sup>	Y Scale Rate LED <sup>4)</sup>	Max Speed LED <sup>5)</sup>	Sewing Counter LED <sup>6)</sup>	Bobbin Winder LED <sup>7)</sup>	Wink Clamp foot lowering LED <sup>8)</sup>	Thread Tension LED <sup>9)</sup>
1 <sup>0)</sup>	1 <sup>0)</sup>	2 <sup>0)</sup>						
2 <sup>0)</sup>	1 <sup>0)</sup>	1 <sup>0)</sup>	1 <sup>0)</sup>					
3 <sup>0)</sup>	1 <sup>0)</sup>	1 <sup>0)</sup>	1 <sup>0)</sup>	1 <sup>0)</sup>	1 <sup>0)</sup>	1 <sup>0)</sup>	1 <sup>0)</sup>	1 <sup>0)</sup>
4 <sup>0)</sup>	0 step of pedal <sup>1)</sup>	1 step of pedal <sup>2)</sup>	2 step of pedal <sup>3)</sup>	1 <sup>0)</sup>	1 <sup>0)</sup>	1 <sup>0)</sup>	1 <sup>0)</sup>	1 <sup>0)</sup>
5 <sup>0)</sup>	Presser solenoid sensor <sup>1)</sup>	Y origin sensor <sup>2)</sup>	X origin sensor <sup>3)</sup>	Thread Clamp origin sensor <sup>4)</sup>	Timing sensor <sup>5)</sup>	Thread Clamp Sensor <sup>6)</sup>	1 <sup>0)</sup>	1 <sup>0)</sup>
6 <sup>0)</sup>	Main shaft angle indication <sup>1)</sup>							
7 <sup>0)</sup>	1 <sup>0)</sup>	1 <sup>0)</sup>	1 <sup>0)</sup>	1 <sup>0)</sup>	1 <sup>0)</sup>	1 <sup>0)</sup>	1 <sup>0)</sup>	1 <sup>0)</sup>
8 <sup>0)</sup>	1 <sup>0)</sup>	1 <sup>0)</sup>	1 <sup>0)</sup>	1 <sup>0)</sup>	1 <sup>0)</sup>	Safety Switch <sup>1)</sup>	1 <sup>0)</sup>	1 <sup>0)</sup>

**2.3.2 CP-2 (Origin Retrieval)**

For origin adjustment, sensor adjustment of X/Y motor. The state of origin sensor and X/Y motor

sensor will be indicated.

1. Preparation

Press  to have access to CP-2, and system displays “0” or “1” at screen.

Then press  to search the origins of thread holding/cutting and presser motors.

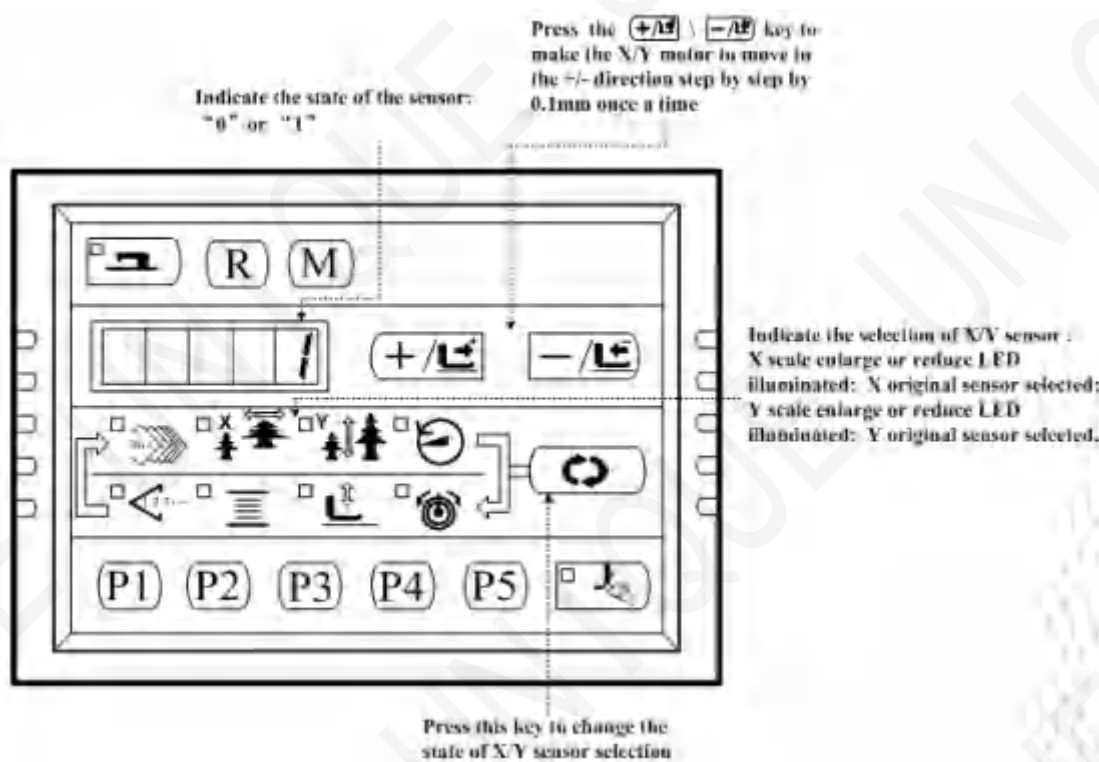

At that time, the presser goes down and the Sewing LED is on (User can also perform step 2 directly without pressing  ).

2. Operation



3. Manual X/Y Origin Adjustment



(1) Step Move Detection: At first, press  to have access to CP-2, the screen will display “--” and the X Scale Rate LED lights up. If the system is not in the ready status and user doesn't







press  to conduct origin retrieval after power on, user can press  or  to

move the X/Y motor step by step. Press  to shift between X/Y motors and the corresponding X/Y Scale Rate LED will light up to indicate the X/Y motor selection. At the same time, the winding LED and the presser LED refer to the signal status of the X motor origin optocoupler and Y motor origin optocoupler respectively: light on represent not covered and light off represents covered.

Winding LED	On	Off
X Origin Optocoupler	Not covered	Covered

Presser LED	On	Off
Y Origin Optocoupler	Not covered	Covered

If the system has ever entered ready status or the user has pressed  to conduct origin retrieval after power on, user need press  to conduct origin retrieval whenever to enter CP-2 mode before user can use direction keys to drive X/Y motor move. Under this circumstance, such operation is to manually adjust X/Y origin.

(2) Manual Origin Adjustment: when the system enters CP-2 and the screen displays "--", press  to make origin retrieval; at this time, the ready key light is on with the screen displaying "0.0" and also the X scale rate LED light is on. The scale rate LED light indicates the currently selected motor, while the number displayed on the LED segment means the origin adjustment value. User can press ,  to change the origin adjustment value and press  to change the selection of X/Y motors. After finishing the origin adjustment value change for both motors, press  to save and quit. If user doesn't want to save the changed value, press  to quit without saving.

### 2.3.3 CP-3 (Continuous Operation)

When "CP-3" is indicated on the screen, press  key to enter the continuous operation mode. Perform the initial setting of the operation conditions, and move to the continuous operation mode.

#### 1) Pause time setting



Press the ,  key to set the time of pause.

Setting range: 1800 ms to 9999 ms (in a unit of 100 ms) (the default value is 2000ms)

Update the time of pause by pressing down the  key, and the setting moves to the automatic origin retrieval setting.



#### 2) Origin retrieval setting

Press the ,  key to set.

A0: Ineffective ;

A1: Every time .



Press the  key to finish setting and move to Pattern No. setting.

#### 3) Continuous Operation

In the Ordinary Sewing Mode, you can change the Pattern No., X./Y scale Enlarge/Reduce setting, the Max speed and so on. The continuous operation can be stopped at the time of

pause by depressing the  key.

### 2.3.4 CP-4 (Main Motor Speed Check)





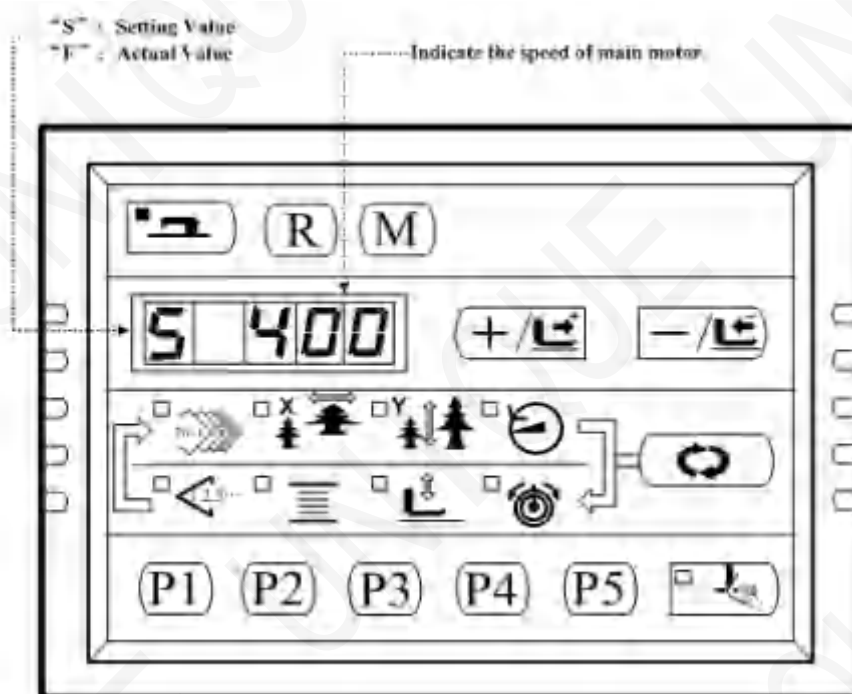

Set the revolving speed of the machine and then only activate the main motor to display the actual revolving speed.

#### 1) Preparation

User shall press  to enter CP-4 to automatically search the origins of motors, including thread- catching motors, presser motors, and thread-trimming motors and at this time, the Sewing LED lights up and the screen displays “S400”.



#### 2) Operation

Press ,  to modify the revolving speed of the main shaft, and then press  to activate the machine to run according to the set speed. At this moment, press  to display the set revolving speed and the actual revolving speed alternatively. If user need change the set speed, repeat the previous speed again. Press  to stop the machine and press  to quit this mode.

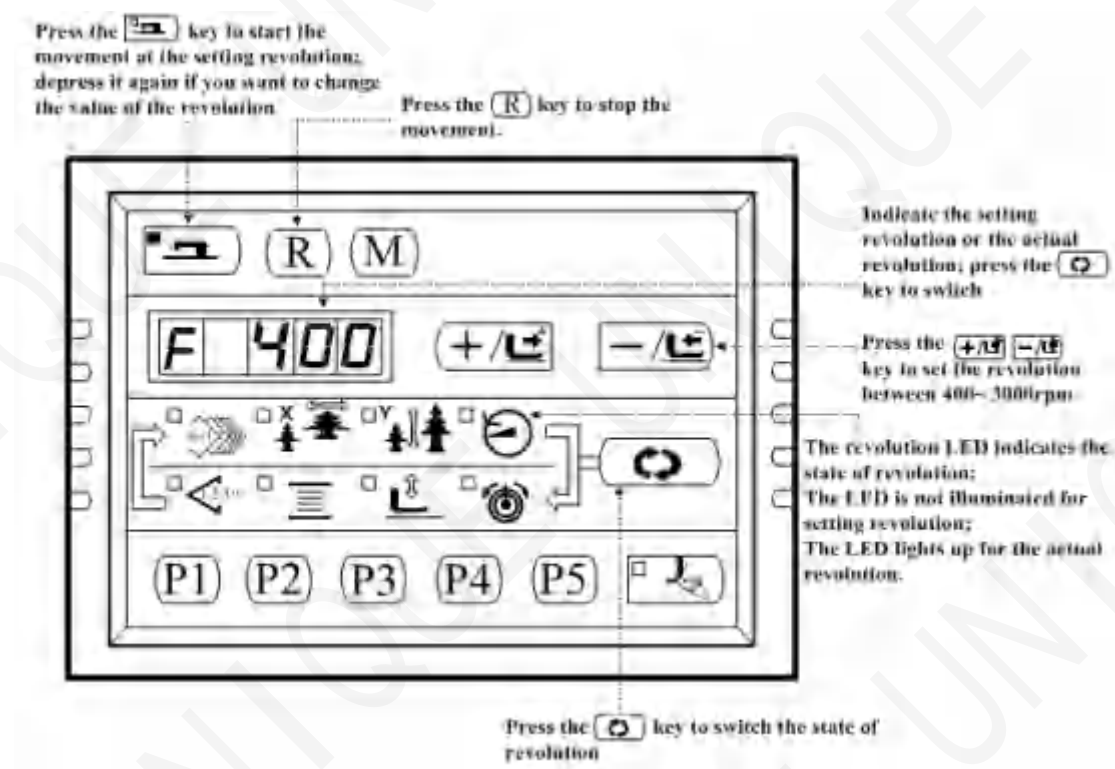

### 2.3.5 CP-6 (Presser and Trimming Motor / Origin Sensor Check)

Indicate the presser and trimming motor to move step by step, origin retrieval and the state of origin sensor and thread trimming sensor.

#### 1). Preparation

Firstly, user can press to enter CP-6; at this time, the sewing LED is on; then step the pedal to level 2 to retrieve the origin. (Note: if the system is not in ready status when power on and enters CP-6, user need not step the pedal to retrieve the origin and can directly use +/- keys to step move the motor to check the status of the motor drive; if the system is in ready status or has done origin retrieval, user need step the padel to level 2 to make origin retrieval whenever the system enters CP-2 before user can press +/- keys to step move the motor.)

#### 2) Operation

Press for 6 to 8 times, if the screen indication changes from "10" to "11", the trimming sensor works well; if not, please make proper adjustment.

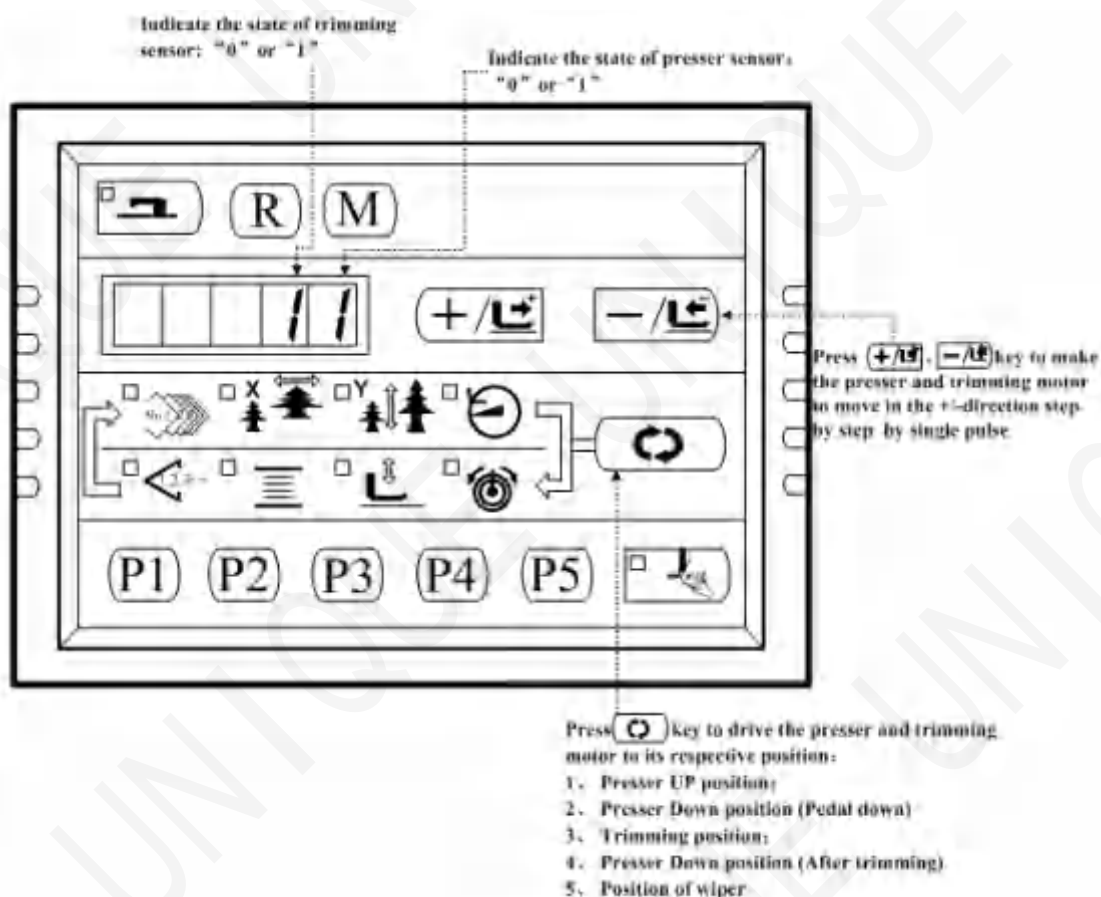

Press **↻** key to perform the functions above in a cycle. And press **M** key to exit this mode.

### 2.3.6 CP-7 (Thread Clamp Motor / Origin Sensor Check)

Indicate the thread clamp motor to move step by step, origin retrieval and the state of origin sensor and thread clamp sensor.

#### 1) Preparation

Firstly, user can press **↻** to enter CP-6; at this time, the sewing LED is on; then step the pedal to level 2 to retrieve the origin. (Note: if the system is not in ready status when power on and enters CP-6, user need not step the pedal to retrieve the origin and can directly use +/- keys to step move the motor to check the status of the motor drive; if the system is in ready status or has done origin retrieval, user need step the pedal to level 2 to make origin retrieval whenever the system enters CP-2 before user can press +/- keys to step move the motor.

#### 2) Operation

Press **+/+**, **-/-** key to make the thread clamp motor move step by step by single pulse.

Press **+/+** key to move the thread clamp backward; press **-/-** key to move the thread clamp forward.

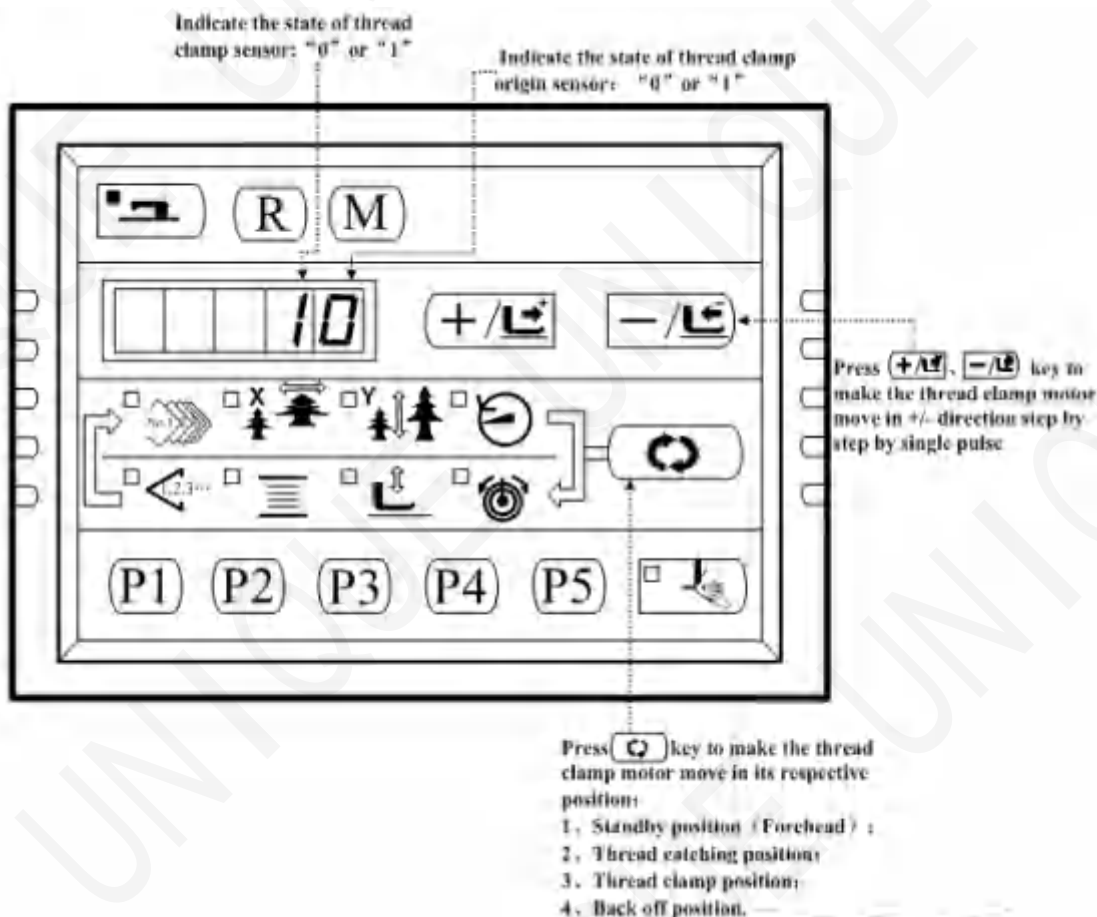

Press key to perform the functions above in a cycle. And press key to exit this mode.

## 2.4 Operation of the Sewing Machine (Basic)

### 2.4.1 Item Data Setting

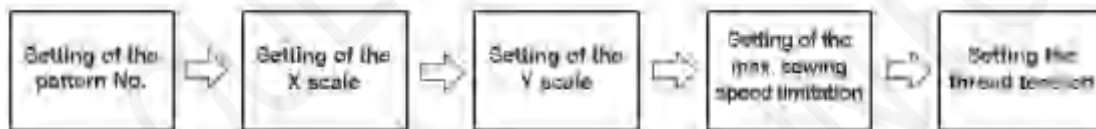

Set each item following the procedure described below.



2. Turn ON the Power Switch  
Pattern No. of the item selection light up, and the pattern No. is indicated on the data display.
3. Setting of the Pattern No.







**4. Setting of the X Scale**

- (1) Press the  key to indicate the item “Pattern No.” .
  - (2) Press the  or  key to indicate “14” on the display.  
(Pattern No. is set to 14.)
- Caution: Refer the pattern No. to the separate table**





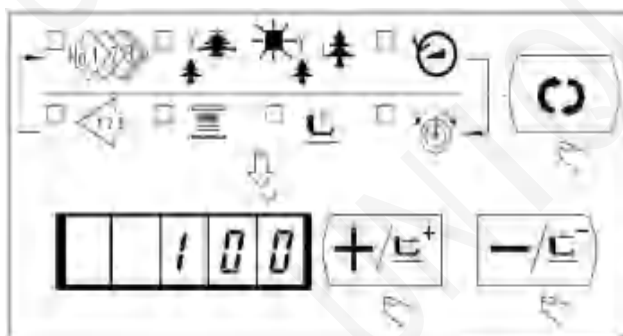

**5. Setting of the Y Scale**

- (1) Press the  key to indicate the item “X scale”  .
- (2) Press the  or  to indicate “100”. (Set X scale to 100%)

**Caution:**  
The setting exceeding 100% is dangerous since the needle and the cloth presser interferes with each other and needle breakage or the like will occur.





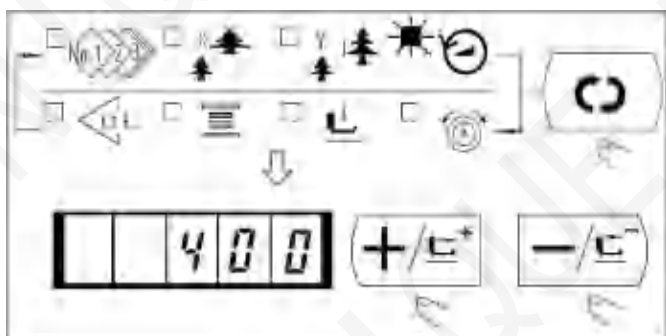

- (1) Press the  key to indicate the item “Y Scale”  .
- (2) Press the  or  key to indicate “100”. (Set X scale to 100%.)

**Caution:**  
The setting exceeding 100% is dangerous since the needle and the cloth presser interferes with each other and needle breakage or the like will occur.

**6. Setting of the Max. Sewing Speed Limitation**



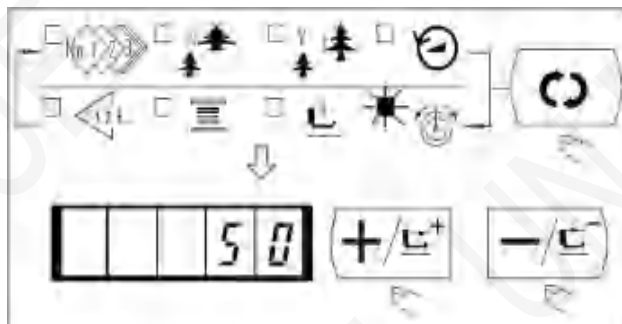

- (1) Press the  key to indicate the item “Speed”  .
- (2) Press the  or  key to indicate “400” (Setting of 400rpm)
- (3) Press R key to set the system default value, the Max. speed.

## 7. Setting the Thread Tension





(1) Press the  key to indicate the

“Thread Tension” .

(2) Press the  or  key to indicate “50” (0 to 200 can be set.)

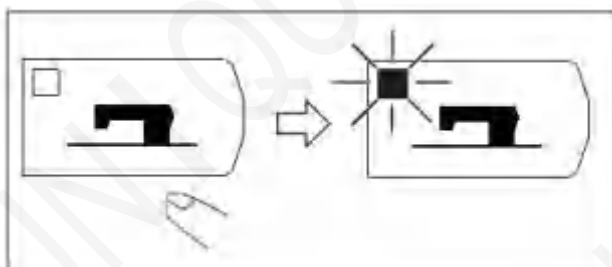
## 8. Finish of Setting







(1) Press the  key.

(2) After the work clamp feet have moved and gone up, the sewing LED lights up, and the sewing is ready.

### Caution:

**When the presser is raised, be careful that fingers are not caught in the presser since the presser moves after having lowered.**

- ★ When  key is pressed, the set value of pattern No., X/Y scale, etc, are memorized.
- ★ If  key is pressed, you can make sure of the respective setting items again. However, the items can not be changed in the state that the Sewing LED is lit up.
- ★ When  key is pressed, the Ready LED goes off. Set values of the respective items can be changed.
- ★ Use the machine after confirming the pattern No. When  key is pressed while the pattern No. is indicated "0"(state at the time of delivery), error display E-10 appears. At this time, re-set the Pattern No.
- ★ When turning OFF the power without pressing  key, the set values of pattern NO., X/Y scale, number of max. rotation, and thread tension are not memorized.

## 2.4.2 Checking the Contour of a Sewing Pattern

### Warning:

**Make sure without fail of the contour of the sewing pattern after selection of the sewing pattern. If the sewing pattern extends outside the work clamp feet, the needle will interfere with the work clamp feet during sewing, causing dangerous troubles including needle breakage.**

(1) Test Sewing

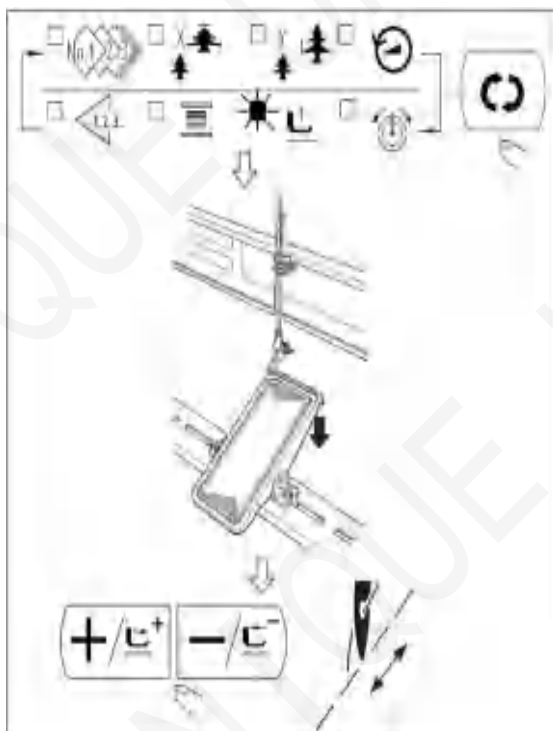

1. Press to light up the Sewing LED.
  2. Press to select , and then the screen displays “SinGL”; step the pedal to lower the presser.
  3. When the presser is down, press .
  4. Use and to confirm the shape. The confirmed pattern for sewing shall be within the permitted range of the presser.
  5. Press to lift presser and return to the sewing start.
- Press to release the selection of (select other data item other than ). After that, press to end the trial sewing

(2) Threading

5. Make sure the sewing LED is off (unready status), and if not, press to turn off the sewing LED.
6. Press to select , and the screen displays .
7. Press to lower the presser to enter the threading status, and the screen displays . Please note that under this condition you cannot press to make other selections.
8. After finishing threading, press again to quit the threading mode.

### 2.4.3 Sewing

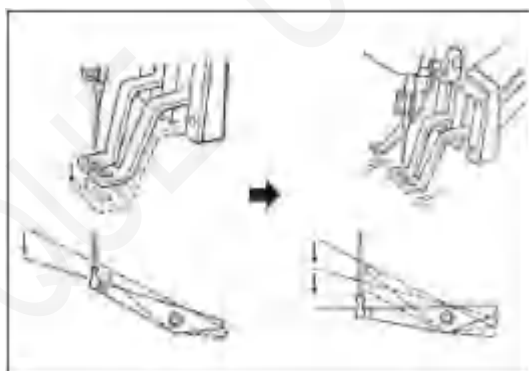

- (1) Set a workpiece on the work clamp foot section.
- (2) Depress the pedal switch to the first step, and the work clamp feet will come down. If you detach your foot from the pedal switch, the work clamp feet will go up.
- (3) Depress the pedal switch to the second step after descending the work clamp feet at the first step, and the sewing machine will start sewing.

### 2.4.4 Change to Other Sewing Pattern

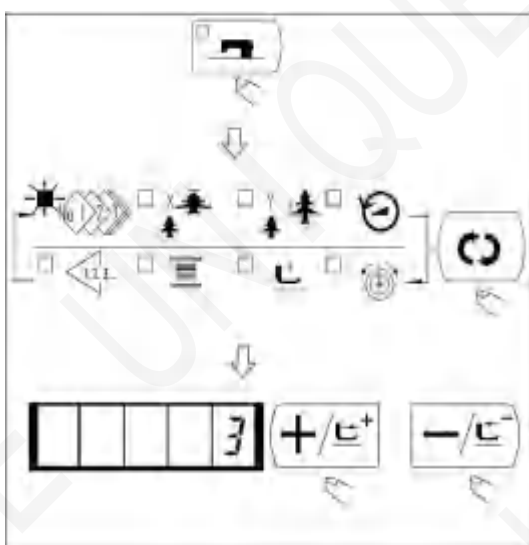

- (4) After the sewing machine completes sewing, the work clamp feet will go up, and return to the sewing start position.

- (1) Make sure the Sewing LED go off with



key.

- (2) Press  key and select the item of

pattern No. .

- (3) Set the pattern No. with  key or



key.

- (4) Similarly, setting of X/Y scale, speed, etc. is performed.





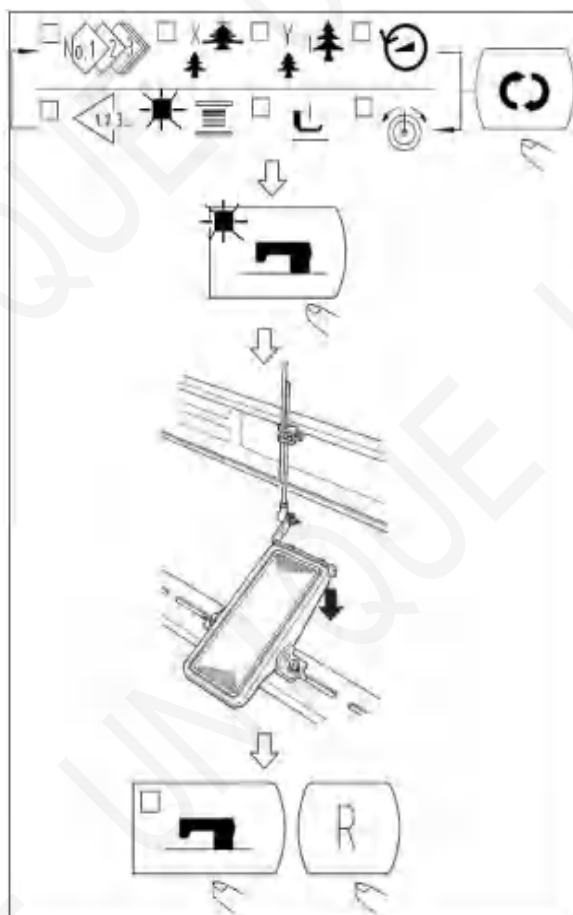

- (5) When  key is pressed, the Sewing

LED light up and the sewing machine is in

### 2.4.5 Winding a Bobbin



The winding device will not work just after power-on. Please select a pattern number and press  to turn on the Sewing LED before the winding operation.

1. Press  to turn off Sewing LED.
2. Press  to select  and the screen will display . (It is unable to select when the Sewing LED is on.)
3. Press  to lower the presser and the Sewing LED lights up.
4. Step the pedal to start the sewing machine and the Sewing LED lights up
5. Step the pedal switch or press  to stop machine and the Sewing LED will be off.

### 2.4.6 Thread Clamp Device

Trouble of sewing (slip-off of needle thread, stitch skipping, or stain of needle thread) at the time of high speed start can be prevented with the thread clamp device. The thread clamp device works in the state that the thread clamp indication LED lights up and does not work when the LED goes off.

Changeover of ON/OFF motion is performed with  key. When the thread clamp device is OFF, the start automatically becomes the slow start.

**Caution:** When memory switch No.35 is "1"(prohibited), the thread clamp does not work.

In addition,  key is ineffective.

#### \*Masters that demand special attention when using the needle thread clamp device

- (1) In case of with the needle thread clamp (motion), make shorter the length of needle thread remaining on the needle at the sewing start for use. When the length of needle thread is lengthened, needle thread on the wrong side of material is apt to protrude. In addition, when the length is excessively lengthened, the end of needle thread held by the needle thread clamp may be rolled in the seams.

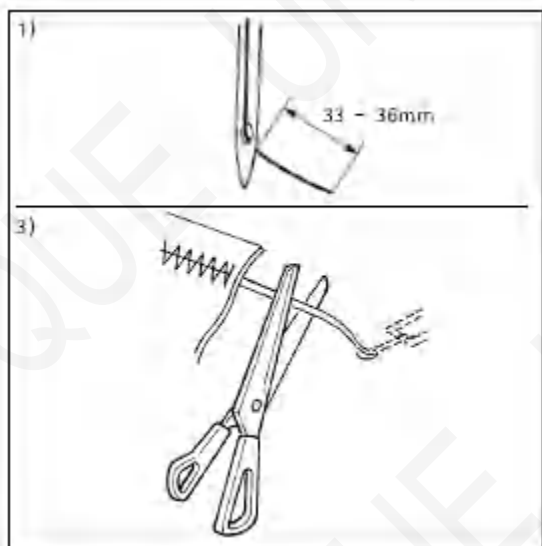

4. In case of with the needle thread clamp, the standard of the length is 33 – 36mm.
5. When needle threadlong after replacing thread or the like or sewing while holding needle thread by hand, Turn OFF the THREAD CLAMP  key.
6. When the needle thread held with the thread clamp is rolled in the seams, do not draw the material forcibly and cut the connecting needle thread with the scissors or the like. The seams are not damaged since it is the needle thread at the sewing start.

(2) It is possible to adjust needle thread shorter by making the needle thread clamp work while holding the stabilized sewing at the start of sewing and the gathering (bird’s nest) of needle thread on the wrong side of material can be lessened. However, for the pattern which the stitch for neatly rolling in needle thread is short, needle thread may protrude from the wrong side of material. Select with/without thread clamp referring to the item below.

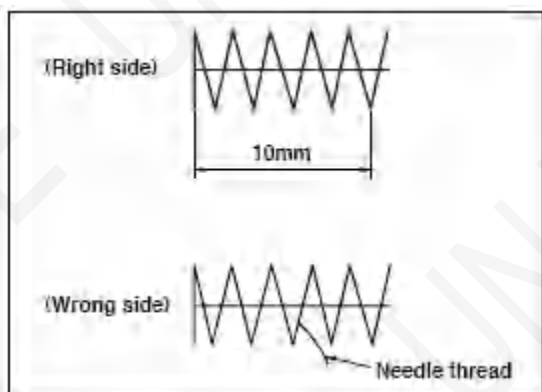

1. When the sewing length is short(less than approximately 10mm), the end of needle thread may protrude like beard even adjusting needle thread shorter.

(3) When the type of lower plate ❶ that material does not come in closely contact with throat plate ❷ is used, needle thread on the wrong side of material may be rolled in the seams regardless of needle thread play or sewing length.

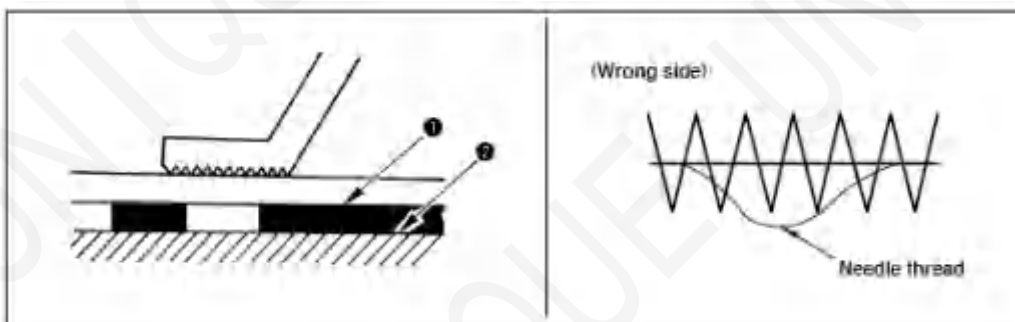



(4) When the thread clamp is used, and bobbin thread at the sewing start appears on the right side

of material, reduce thread tension at the sewing start (2 to 3 stitches) and bobbin thread becomes less conspicuous.

[Example of setting ] Tension of 1 to 2 stitches at the sewing start is “20” when sewing tension setting is “35”.

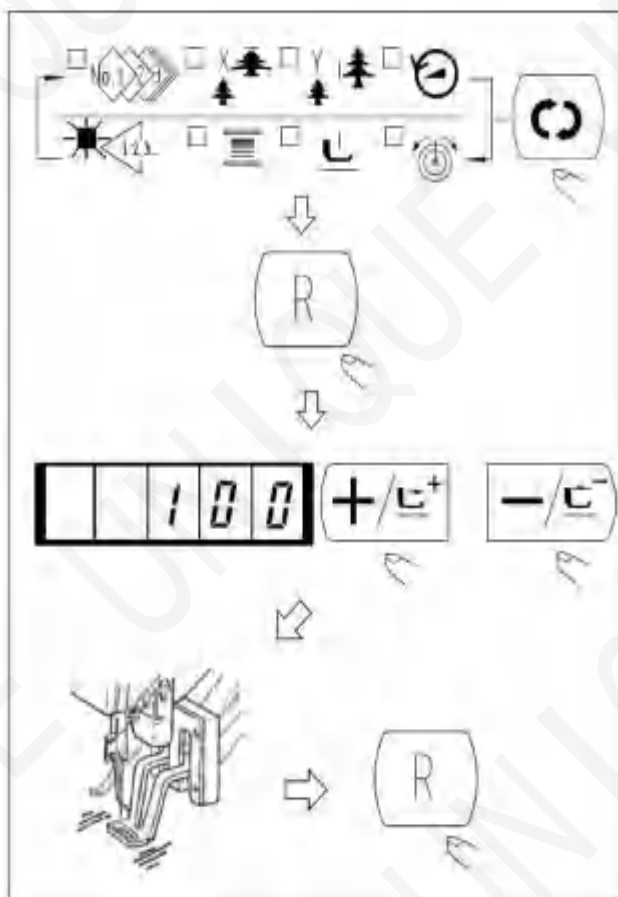

### 2.4.7 Bobbin Thread Counter



(1) Press  key to indicate the Counter

 1.2.3...

(2) Then press the  key.

(3) Then press the  or  key, and set the specified number of times that can be sewn with a bobbin.

(4) Every time, the sewing machine finishes a sewing cycle, counting-down is made by one.

(5) When the sewing machine finishes the specified number of times, the sewing machine does not start even if depressing the pedal.

(6) Replace the bobbin with a new one, and press the  key. The value of the counter returns to the set value.

(7) Repeat the steps of procedure from the steps (3) to (5).

### 2.4.8 Temporary Stop

1. Pedal Stop Function: The new pedal has three levels: Level 1 for lowering presser; Level 2 for normal sewing; Level 3 for emergency stop.





- 4) Press Ready Key and step the front part of pedal ↓ to lower the presser;
- 5) Step the front part of pedal ↓ to start sewing;
- 6) During sewing, if user needs to stop machine immediately, user can step the back part of the pedal ↓ to stop machine, and the screen will display



2. Emergency Stop from Panel: When parameter No.31 is set to "1", (R) key can be used as the temporary stop key.

3. Tread-trimming and manual frame movement operations after the above-mentioned emergency stops



- (1) When the screen displays  in case of emergency stop, press (R) key to clear the error information and the machine will execute thread-trimming operation. When the panel displays "MovE", user can conduct manual frame movement.
- (2) At this time, user can press  or  to manually move the frame to feed and then step the pedal at level 2 to finish the sewing, or press again (R) key to return to the origin.

#### 2.4.9 Setting the Pattern Thread Tension

Needle thread tension for 6 stitches at the sewing start, the portion which is changed over from basting stitch to zigzag stitch, and the portion of the stitch at the sewing end can be individually set.

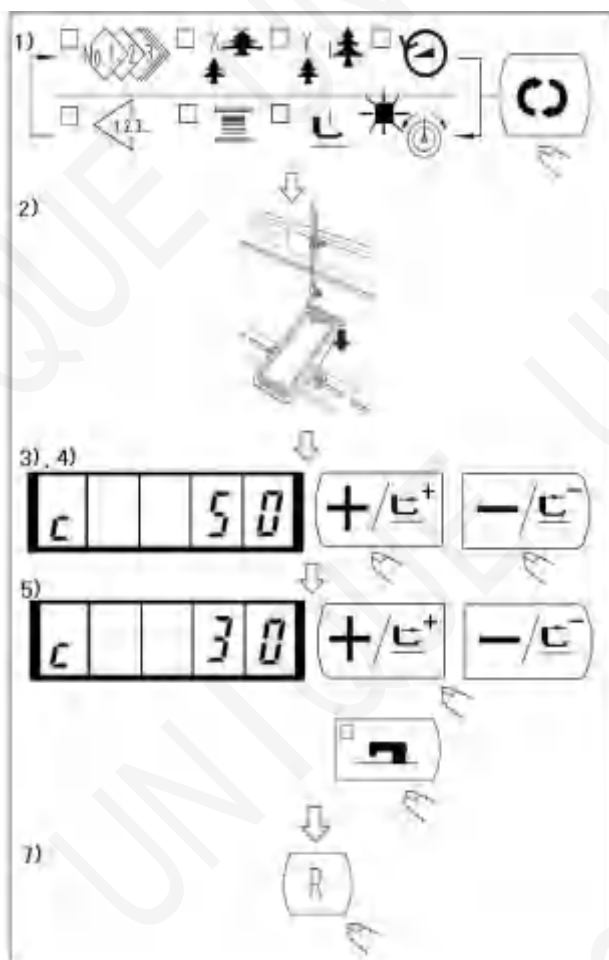

















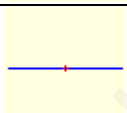
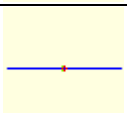
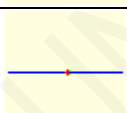
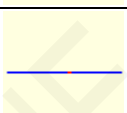
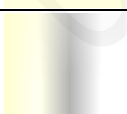
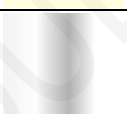

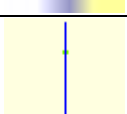
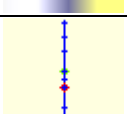
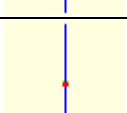
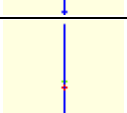
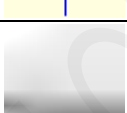
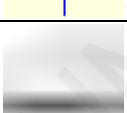

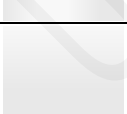



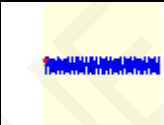
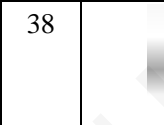

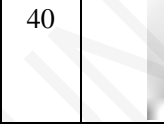

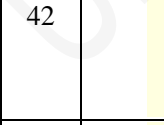
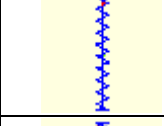
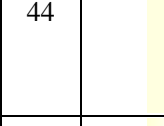
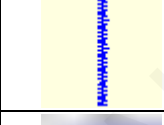
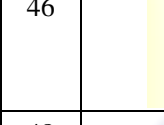
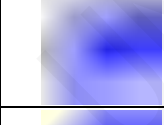
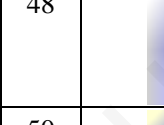
- 8) When the sewing LED lights up, press key to indicate the needle thread tension .
- 9) Lower the presser with foot pedal. **(Caution: When the foot pedal is depressed until it will go no further, the sewing machine starts. So, be careful.)**
- 10) Move the feed with or key.
- 11) “c” is indicated at the position where the tension position is possible.
- 12) Pressing key, set the tension with or key.
- 13) Repeat steps 3), 4) and 5) to set the tension.
- 14) When setting is complete, press key. The presser moves to the origin and goes up.

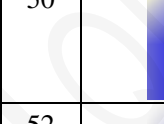
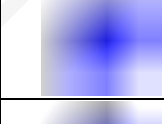
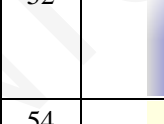
### 2.4.10 Table of the Standard Patterns

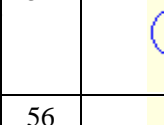
2.4.11

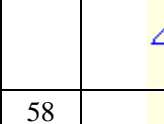
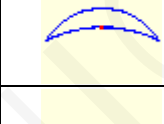
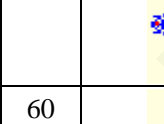
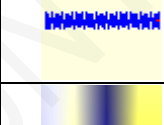
NO.	Stitch Diagram	Numbers of Stitches	L×W (mm)	NO.	Stitch Diagram	Numbers of Stitches	L×W (mm)
1		41	16.1×2	2		41	10.2×2
3		41	16×2.4	4		41	24×3
5		27	10.1×2	6		27	16×2.4
7		35	10.1×2	8		35	16×2.4
9		55	24×3	10		63	24×3

NO.	Stitch Diagram	Numbers of Stitches	L×W (mm)	NO.	Stitch Diagram	Numbers of Stitches	L×W (mm)
11		20	6.1×2.4	12		27	6.2×2.4
13		35	6.1×2.4	14		14	8×2
15		20	8×2	16		27	8×2
17		20	10×0	18		27	10×0
19		27	25.2×0	20		35	24.8×0
21		40	25.2×0	22		43	35×0
23		27	4×20	24		35	4×20
25		41	4×20	26		55	4×20
27		17	0×20	28		20	0×10
29		20	0×20	30		27	0×20
31		51	10.1×7	32		62	12.1×7
33		23	10.2×6	34		30	12×6
35		47	7×10	36		47	7×10

NO.	Stitch Diagram	Numbers of Stitches	L×W (mm)	NO.	Stitch Diagram	Numbers of Stitches	L×W (mm)
37		89	24×3	38		27	8×2
39		25	11.8×12	40		45	12×12
41		28	2.4×20	42		38	2.4×25
43		38	2.4×25	44		57	2.4×30
45		75	2.4×30	46		41	2.4×30
47		89	8×8	48		98	8×8
49		147	8×8	50		163	8×8
51		110	7.9×7.9	52		120	7.9×7.9
53		130	7.9×7.9	54		51	12.4×10.2
55		50	12.4×10.2	56		52	21×6
57		57	21×6	58		102	19×3
59		115	40×5	60		115	40×5
61		308	6×25	62		257	6×20

NO.	Stitch Diagram	Numbers of Stitches	L×W (mm)	NO.	Stitch Diagram	Numbers of Stitches	L×W (mm)
63		108	40×30	64		80	40×30
65		64	40×30	66		96	30×30
67		76	30×30	68		60	30×30
69		52	40×30	70		40	40×30
71		32	40×30	72		44	30×30
73		36	30×30	74		28	30×30
75		60	40×30	76		48	40×30
77		36	40×30	78		56	30×30
79		44	30×30	80		36	30×30
81		67	40×30	82		51	40×30
83		39	40×30	84		55	30×30
85		35	30×30	86		42	30×30
87		145	16.2×16.2	88		153	12×12.4

NO.	Stitch Diagram	Numbers of Stitches	L×W (mm)	NO.	Stitch Diagram	Numbers of Stitches	L×W (mm)
89		74	20×24	90		54	20×24
91		65	20×20	92		49	20×20
93		39	20×20	94		63	25×20
95		51	25×20	96		45	25×20
97		42	25×20	98		33	25×20
99		27	25×20	100		88	30×25

## 2.5 Operations of P Pattern and C Pattern

### 2.5.1 Perform Sewing Using the Pattern Key

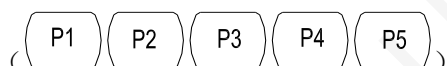

Patterns (No.1 to 200) which have been already registered can be registered to P1 to P99. It is possible to change and register the scale, max speed limitation, thread tension and sewing position. Same as the patterns (No.1 to 200), P1 to P50 are used by the selection by scrolling the pattern Nos. The pattern calling from P1 to P25 can be made by one-touch as well.

When selecting P6 to P25, perform the selection by combination (simultaneously pressing) of

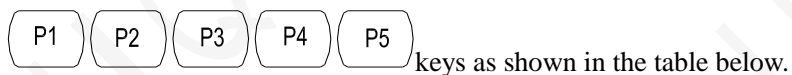

P-No.	Selection Key	P-No.	Selection Key	P-No.	Selection Key	P-No.	Selection Key
P1	P1	P8	P1+P4	P15	P4 +P5	P22	P2+P3+P4
P2	P2	P9	P1+P5	P16	P1+P2+P3	P23	P2+P3+P5
P3	P3	P10	P2+P3	P17	P1+P2+P4	P24	P2+P4+P5

P4	P4	P11	P2+P4	P18	P1+P2+P5	P25	P3+P4+P5
P5	P5	P12	P2+P5	P19	P1+P3+P4		
P6	P1+P2	P13	P3+P4	P20	P1+P3+P5		
P7	P1+P3	P14	P3+P5	P21	P1+P4+P5		

1. Register of the Pattern Key

Setting example: Register following setting to the P2, Pattern No.3, X scale rate: 50%, Y scale rate: 80%, Max. speed limitation: 2000 rpm, Pattern position: 0.5 mm to the right and 1 mm to the front.

1) Turn ON the power switch and press **(M)** key to enter mode setting (memory switch setting).

(Sewing LED should be put out.)

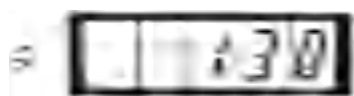

2) Indicate the pattern register mode

with **(+/-<sup>+</sup>)** or **(-/-<sup>-</sup>)** key.



3) Press **(P)** key.



Enter the pattern register mode.

4) Press **(P2)** key. (Select P-No. to be registered.)

Selection can be performed with **(+/-<sup>+</sup>)** or **(-/-<sup>-</sup>)** key.



5) Press **(No.1-2)** key to indicate the Pattern No.

Set the Pattern No. to "3" with **(+/-<sup>+</sup>)** or **(-/-<sup>-</sup>)** key.



6) Press **(No.1-2)** and set as follows with **(+/-<sup>+</sup>)** or **(-/-<sup>-</sup>)** key.

X Scale rate  : 50%,



Y Scale rate  : 80%,





Max speed limitation  :  
"2000" rpm



Thread Tension  "50"





7) Press  key and "X Scale rate "  
indication becomes 0.0.



Traveling amount in X direction can be

set in 0.1mm unit. Set 0.5 with  or  key.



8) Press  key and "Y Scale rate "  
indication becomes 0.0.

Traveling amount in Y direction can be

set in 0.1mm unit. Set -1.0 with  or  key.



9) Press  key to finalize the setting.



10) Press  key.



Pattern register mode is finalized.

11) Press  key.

Mode setting is finalized and the mode returns to the normal mode.

## 2. Sewing

Operation Example: After perform sewing of the contents of the register P2, perform sewing with the contents of P3.

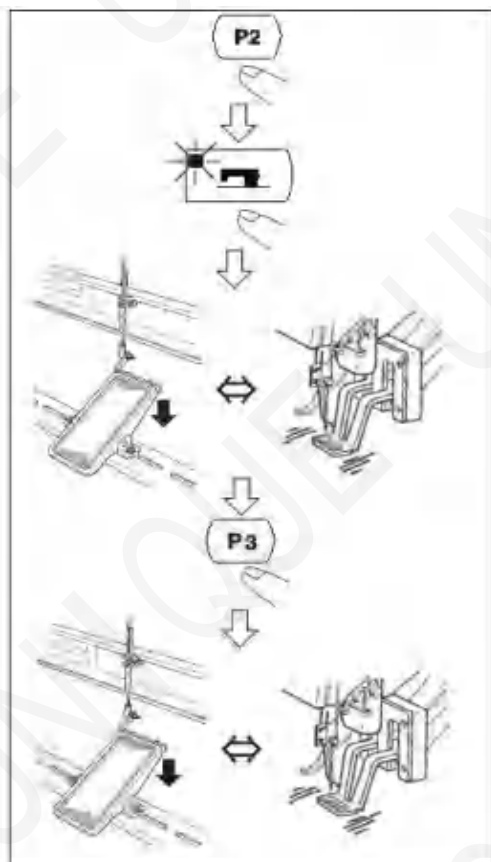

(1) Turn ON the power switch.

(2) Press the  key.

(3) Press the  key, and when the sewing LED lights up, the work clamp foot goes up after it has moved.

(4) Check the contour of the sewing pattern.  
(Refer to the item “Checking the Contour of a Sewing Pattern”).

(5) If the contour of the sewing pattern is acceptable, the sewing can be made.

(6) Press  key after completion of sewing and the presser comes down. The presser moves to the sewing start point after origin retrieval and goes up.

(7) Perform the above item (4) and (5).

### 2.5.2 Perform Sewing Using the Combination Function

By arranging in order to use the pattern register (P1 to P99) which have been already registered

and registering in C1 to C50, the sewing pattern will change in the order every time the sewing machine finishes the sewing. Every one combination No. can be registered up to the maximum 99 patterns.

**i. Register of the Combination**

Setting example: Combine in the order of P1, P2 and P3, and register them in the C1.



- 1) Turn ON the power switch and press  key to enter the mode setting (memory switch setting).  
(Sewing LED should be put out.)





- 2) Indicate the combination mode with  or  key.



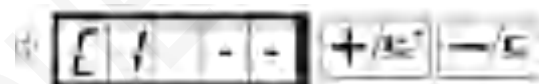

- 3) Press  key. Sewing LED lights up to enter the combination mode. C1 to C50 can be selected with

 or  key.





- 4) Press  key, and then press  key.



 is set to the first pattern of C1. P1

to P99 can be selected with  or  key as well.





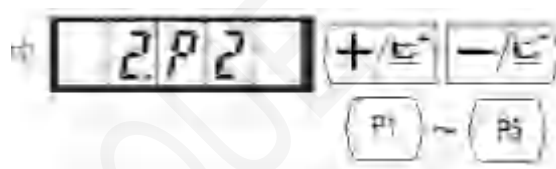

- 5) Press  key, and then press  key.

P2 is set to the second pattern of C1. P1

to P99 can be selected with  or  key as well.



- 6) Press  key, and then press  key.  
 P3 is set to the third pattern of C1. P1 to P99  
 can be selected with  or  key as well.

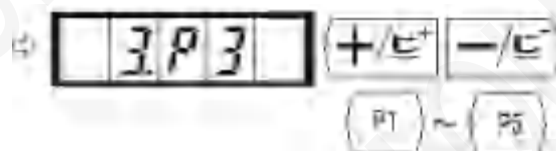

- 7) Press  key to finalize the register.



- 8) Press  key. Combination register mode is finalized.



- 9) Press  key.  
 Mode setting is finalized and the mode returns  
 to the normal mode.



## ii. Sewing Operation

Operation example: Perform sewing with the contents of the registered C1.

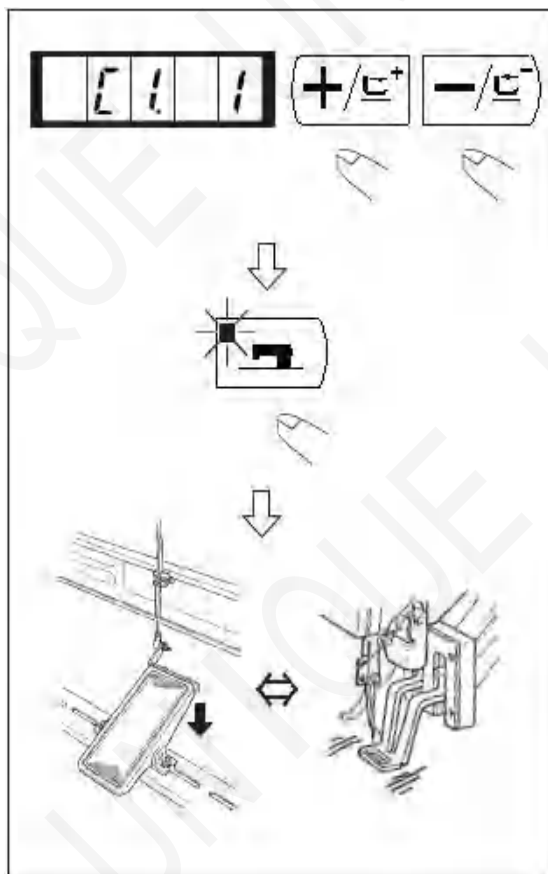

- (1) Turn ON the power switch.
  - (2) Set the pattern No. to “C1” using the  $\boxed{+/\epsilon^+}$  or  $\boxed{-/\epsilon^-}$  key.
  - (3) Press the  $\boxed{\text{LED}}$  key. When the sewing LED lights up, the work clamp feet will go up after having moved.
  - (4) If the contour of the pattern is acceptable, the sewing can be made.
  - (5) Every time the sewing is finished, the step is made in the order of the combination. After completing one cycle of sewing., the step returns to the first step.
- ✧ When you desire to return the pattern to the previous one or skip the next pattern after sewing, press  $\boxed{+/\epsilon^+}$  or  $\boxed{-/\epsilon^-}$  key in a state that the sewing LED lights up.
  - ✧ If the contents of P1 to P99 are changed after registration of C1 to C50, the contents of P1 to P99 used in C1 to C50 will change. So, be careful.
  - ✧ Make sure of the contour of the pattern for each or the patterns. (Refer to the item “Checking the contour of the sewing pattern”.)

## 2.6 How to Use the Memory Switch (User Class)

The sewing machine operation can be changed by changing the setting of the memory switch.

### 2.6.1 Start and Change of the Memory Switch

- 1) When  $\boxed{M}$  key is pressed in the state that the sewing LED is put out, the memory switch setting mode is obtained.

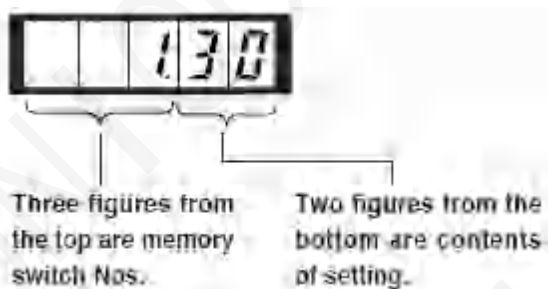

- 2) Change the memory switch No. with

$\boxed{+/\epsilon^+}$  or  $\boxed{-/\epsilon^-}$  key.



**1.30** which is indicated when “M” key is pressed indicates that the max. speed limitation of the first memory switch is 3,000 rpm. (State at the time of delivery from factory)

3) Adjust the memory switch No. to the No.

you desire to change, and press  key,

the sewing LED lights up.

4) Change the content of the memory switch

with  or  key.



5) The value can be returned to the value at the time of delivery from the factory with  key.

6) Press  key to register the contents of change. Sewing LED goes off and the mode returns to the selective state of the memory switch No.

7) Press  key to finalize the memory switch setting mode and the mode returns to the normal mode.

## 2.6.2 Example of the Memory Switch Setting

1. Setting the Max. speed Limitation

Setting example: Setting the max. speed limitation to 1,800 rpm.

1) Press  key in the state that the sewing LED is put out.



The memory switch is started and the contents of memory switch No.1 are indicated.



It is not necessary to change the sewing speed since the max. speed limitation of the sewing machine is set with memory switch No.1. The indicated memory switch No. can be changed

over with  or  key.

2) Press  key in the state that memory switch

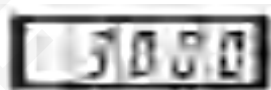
NO.1 is indicated to make the sewing LED light up. The contents of memory switch No.1 (max. speed limitation value of the sewing machine ) are indicated.



3) Set "1800" with  or  key.



4) Register the value with  key. Sewing LED goes off.

5) Press  key to return to the normal state.

2. Setting the Soft Start Speed at the Sewing Start

The speed of the first stitch to the fifth stitch at the sewing start can be set in a unit of 100 rpm. Two kinds of settings, in case of with needle thread clamp and without needle thread clamp can be performed. (See Table of Functions of the Memory Switch.)

In case of needle thread clamp unit: rpm

	State when delivered (rpm)	Setting range
<b>1<sup>st</sup> Stitch</b>	1500	400~1500
<b>2<sup>nd</sup> Stitch</b>	3000	400~3000
<b>3<sup>rd</sup> Stitch</b>	3000	400~3000
<b>4<sup>th</sup> Stitch</b>	3000	400~3000
<b>5<sup>th</sup> Stitch</b>	3000	400~3000

Setting Example: In case of with needle thread clamp, the speed is changed as follows.

1<sup>st</sup> stitch form 1,500 to 1,000 rpm and 2<sup>nd</sup> stitch form 3,000 to 2,000 rpm.

1) Press  in the state that the sewing LED is put out.







2) Indicate memory switch No.2 with 

or  key. Here, set the sewing speed of the first stitch.

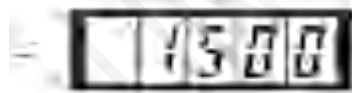

3) Press  key. The sewing LED lights up and the set value of the first stitch is indicated.



4) Indicate “1000” with  or  key. The value returns to the initial value at the time of delivery from the factory with  key.



Press  key to cancel the operation here and

return to the state of step 2).

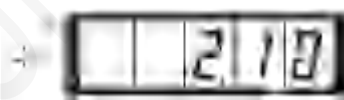

- 5) Press  key. The sewing LED goes off and the set value of the first stitch is registered.







- 6) Indicate memory switch No.3 with  or  key. Here, set the sewing speed of second stitch.



- 7) Press  key. The sewing LED lights up and the set value of the second stitch is indicated.



- 8) Indicate "2000" with  or  key. The value returns to the initial value at the time of delivery from the factory with . Press  key to cancel the operation here and return to the state of step 6).



- 9) Press  key. The sewing LED goes off and the set value of the second stitch is registered.

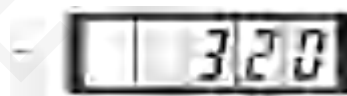

- 10) Press  key. The memory switch setting mode is finalized and the mode

returns to the normal mode.

3. Setting Whether the Calling of Pattern Data is Operative or Not

By making inoperative the calling of the unnecessary pattern, this setting prevents the different pattern from calling by mistake.

Also, it is possible to call and use the necessary pattern.

Setting Example: Make the calling of pattern Nos.2 and 3 inoperative.

- 1) Press  key in the state that the sewing LED is put out.



- 2) Indicate memory switch No.201 with  or  key.





- 3) Press  key. The sewing LED lights up and the set value of pattern No.1 is indicated.



Set value 1: Calling is operative.

Set value 0: Calling is inoperative.

- 4) Set pattern No.2 with  or  key



- 5) Set the set value to "0" with  key.

- 6) Set the pattern No.3 with  or  key.

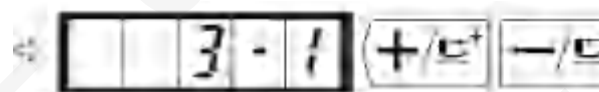

- 7) Set the set value to "0" with  key.

8) Press  key to register the set value. The





9) Press  key. The memory switch setting mode is finalized and the mode returns to the normal mode.

4. Setting the Counter Operation

Setting Example: The production counter (adding method) can be changed to the bobbin thread counter (subtracting method).

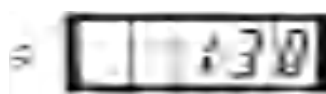
1) Press  key in the state that the sewing LED is put out.



2) Indicate the memory switch No.18 with  or  key.



3) Press  key. The sewing LED lights up and the set value of counter motion is indicated.

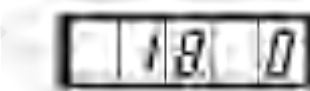

4) Set the set value to “1” with  key.  
Set value 0: Production counter  
Set value 1: Bobbin thread counter



5) Press  key to register the set value. The sewing LED goes off.

6) Press  key. The memory switch setting mode is finalized and the mode returns to the normal mode.

2.6.3 Table of Functions of the User Class Memory Switch

No.	Functions	Adjustment Range	Default Value	Remarks
-----	-----------	------------------	---------------	---------

No.	Functions	Adjustment Range	Default Value	Remarks
1.30	Max Speed of Sewing (it can be set in step of 100rpm)	400~3200	3000	
2.15	Sewing speed of 1 <sup>st</sup> Stitch (thread-catching) (It can be set in step of 100rpm)	400~1500	1200	
3.30	Sewing speed of 2 <sup>nd</sup> Stitch (thread-catching) (It can be set in step of 100rpm)	400~3200	2500	
4.30	Sewing speed of 3 <sup>rd</sup> Stitch (thread-catching) (It can be set in step of 100rpm)	400~3200	2700	
5.30	Sewing speed of 4 <sup>th</sup> Stitch (thread-catching) (It can be set in step of 100rpm)	400~3200	3000	
6.30	Sewing speed of 5 <sup>th</sup> Stitch (thread-catching) (It can be set in step of 100rpm)	400~3200	3200	
7.--	Thread tension of 1 <sup>st</sup> Stitch (thread-catching)	0~200	200	
8.--	Thread tension at the time of thread-trimming	0~200	0	
9.--	Changeover time of thread tension at thread-trimming	-6~4	4	
10.4	Sewing speed of 1 <sup>st</sup> Stitch ( no thread-catching) (It can be set in step of 100rpm)	400~1500	400	
11.9	Sewing speed of 2 <sup>nd</sup> Stitch ( no thread-catching) (It can be set in step of 100rpm)	400~3000	900	
12.30	Sewing speed of 3 <sup>rd</sup> Stitch (no thread-catching) (It can be set in step of 100rpm)	400~3000	3000	
13.30	Sewing speed of 4 <sup>th</sup> Stitch (no thread-catching) (It can be set in step of 100rpm)	400~3000	3000	
14.30	Sewing speed of 5 <sup>th</sup> Stitch (no thread-catching) (It can be set in step of 100rpm)	400~3000	3000	
15.--	Thread tension of 1 <sup>st</sup> Stitch (no thread-catching)	0~200	0	
16.--	Changeover timing of thread tension at the sewing start (no thread-catching)	-5~2	0	

No.	Functions	Adjustment Range	Default Value	Remarks
17.0	Whether to change or indicate the XY scale rate and max speed limitation	0: changeable 1: unchangeable	0	
18.0	Action of Counter	0: Production Counter (Adding Method) 1: Robbin Thread Counter (Subtracting Method)	0	
25.1	Presser Division	0: Divide 1: Not divided;	1	
26.70	Adjustment of presser height in section	50~90	70	
31.0	Use keyboard (Clear Key) to stop sewing machine	0: invalid 1: RESET key	0	
32.1	Buzzer forbidden	0: no voice 1: panel operation voice 2: panel operation voice and alarm voice	2	
33.1	Set number of stitches that thread-catching releases	1~7	2	
34.--	Time deferrable in catching thread	-20~0	0	
35.1	Enable to forbid the control on catching upper thread	0: Normal 1: Forbidden	1	
36.--	Select the Feed time. When stitches are not well tightened, set the value in “-” direction.	-8~16	12	
37.1	Presser status at sewing end	0: Back to sewing start and then lift 1: Back to sewing start and at the same time lift	1	
39.0	Search origin at sewing end of each time	0: Not search origin 1: Search Origin	0	
40.0	Search origin at cyclic sewing	0: Not Search origin 1: Search origin after the finish of each pattern	0	

No.	Functions	Adjustment Range	Default Value	Remarks
41.0	Search origin at sewing of P pattern	0: Not search origin 1: Search Origin	0	
42.0	Stop position of needle bar	0: upper position 1: highest position	0	
46.0	Forbid thread-trimming	0: normal 1: forbid thread-trimming	0	
49.16	Set winding speed	800~2000	1600	
55.0	Forbid start back tacking at button sewing	0: start back tacking 1: no start back tacking	0	
62.0	Pattern data update	0: normal mode 1: import (add) pattern to replace the existing pattern with the same pattern number 2: export all extraposition patterns to USB storage device 3: clear (format) the storage area for extraposition patterns	0	
63.0	Setting method of X/Y scale rate	0: by percentage 1: by size	0	
97.1	Thread-trimming method after temporary stop	0: automatic thread-trimming 1: manual thread-trimming	1	
135.0	Presser movement order before sewing	0: stand-by at the sewing start 1: stand-by at the origin	0	
167.5	Brightness of LED lights lamp at the machine head	0~10	5	The larger value, the brighter; 0 means off.

No.	Functions	Adjustment Range	Default Value	Remarks
201.--	Whether to read the pattern data.	0: unable 1: able	Up to machine type	
212.0	Air valve separate presser lowering order	0: lowering at the same time 1: lower left presser first and then right presser 2: lower right presser first and then left presser	0	
213.0	Air valve separate presser lifting order	0: lowering at the same time 1: lift left presser first and then right presser 2: lift right presser first and then left presser	0	
214.1	Overturn Presser Availability	0: forbidden 1: available	1	
P- - -	Register pattern			
C- - -	Register the cyclic sewing			

### 3. Memory Switch (Service Class)

Service class memory switch is different from the user class and it is not allowed to be changed by users. We provide these functions to the professional for adjustment and maintenance.

#### 3.1 Start and Change of the Memory Switch (Service Class)

When  key is pressed in the state that the sewing LED is put out, the memory switch setting mode is obtained and

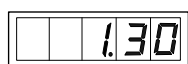

is indicated. Then press

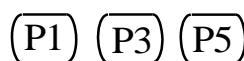

simultaneously, and you will hear the buzzer ring. After that you have started the memory switch and you are allowed to change the settings.

The operation of service class memory switch is the same as that of user class memory switch. Refer to **【2.6 How to Use the Memory Switch (User Class)】** for details.

#### 3.2 Table of Functions of the Service Class Memory Switch

No.	Definition	Adjustment Range	Initial Value	Remarks
19.30	Lifting time of pneumatic outer frame	0~90	30	
21.--	Positions of standard pedal & pedal switch	50-200	70	
22.--	Position of standard pedal & stroke switch of high/low section.	50-200	120	
23.--	Position of standard pedal & start switch	50-200	185	
24.0	Pedal Type	0: Analog Single Pedal 1: Digital Singel Pedal 2: Double Pedals 3: Double Pedals, but only the operation pedal controls	0	
27.--	Dropping speed of presser at depressing pedal	100-4000pps	4000	
28.--	Lifting speed of presser at depressing pedal	100-4000pps	1500	
29.--	Lifting speed of thread-trimming presser at	100-4000pps	3000	

No.	Definition	Adjustment Range	Initial Value	Remarks
	sewing end			
38.--	Start sewing with switch when presser keeps still	0: Normal 1: Not lift presser	0	
43.4	Selection of machine rotating number at thread-trimming	3~7	4	
44.0	Selection on whether to feed cloth in the easy direction at thread-trimming	0: Not Feed 1: Feed Cloth	0	
45.16	Guide diameter of needle hole for feeding cloth at thread-trimming (Changing step can be set at 0.2mm.)	16~40 (1.6mm~4.0mm)	16	
56.--	Limited range of motion in +X direction (Right)	0~50mm	20	
57.--	Limited range of motion in -X direction (Left)	0~50mm	20	
58.--	Limited range of motion in +Y direction (Back)	0~30mm	15	
59.--	Limited range of motion in -Y direction (Front)	0~30mm	15	
64.0	Select thread wiping method	0: solenoid 1: motor	1	
65.--	System device software version	1. PAnL: software version of control panel 2. Ctrl: software version of lower computer 3. dSP1: software version of stepping motor DSP1 4. dSP2: software version of stepping motor DSP2		Enter the submenu for more detailed information
66.45	Impulse number for coactions of presser and wiper	30~60	45	
67.8	Default parameter transfer	0~90	Up to machine type	Effective after restart
70.--	Firmware program update of the system	1-PnL: firmware program update of the panel 2-Ctr: firmware program		Enter the submenu for more detailed information

No.	Definition	Adjustment Range	Initial Value	Remarks
		update of the main control		
74.1	Presser control mode shift	0: air valve control 1: motor control	1	
95.--	Thread-trimming angle	-10~10	0	
102.7	X stepping motor full-current parameter	0~15	7	Effective after restart
104.11	Y stepping motor full-current parameter	0~15	11	Effective after restart
106.2	Thread-catching stepping motor full-current parameter	0~15	2	Effective after restart
108.14	Presser stepping motor full-current parameter	0~15	14	Effective after restart
109.7	X stepping motor semi-current parameter	0~15	7	Effective after restart
110.6	Y stepping motor semi-current parameter	0~15	6	Effective after restart
111.5	Presser stepping motor semi-current parameter	0~15	5	Effective after restart
112.--	Main shaft stop correction	-10~10	0	
121.0	Counter Lock	0: Can Clear and Plus/Minus ; 1: Can Clear Only ; 2: Can Plus/Minus Only; 3: Can not Clear and Plus/Minus	0	Need unlock password
120.--	Alarm to add lubricating oil	3000~12000	5000	Unit: ten thousand stitches
122.--	OC length adjustment	-128~128	0	
123.--	OD length adjustment	-128~128	0	
124.--	BD length adjustment	-512~512	0	
125.--	OC length	1780~2380	2080	
126.--	OD length	1440~2040	1740	

No.	Definition	Adjustment Range	Initial Value	Remarks
127.--	BD length	430~630	530	
128.0	Stepping Open/Close Loop Shift	0: DSP1Close DSP2Close 1: DSP1Open DSP2Open 2: DSP1Close DSP2Open 3: DSP1Open DSP2Open	0	Effective after restart
136.--	Thread-separating delay	-10~30	0	
137.--	Thread clamp release angle at sewing start	-150~150	0	
138.--	Thread clamp time after trimming at sewing start	-1~1	0	
140.0	Thread Tension Control Method	0: electronic clamp 1: machanical clamp	0	
141.--	Suction force adjustment of branch thread tension solenoid	-20~20	0	
142.--	Holding force adjustment of branch thread tension solenoid	-40~40	0	
150.0	Invalidity of head tilt safety switch	0: Normal 1: The safe shape of head tilt is invalid.	0	
163	Intermediate Presser Control Method	0: no control 1: not used 2: solenoid control 3: mechanical control	0	
174.1	Sensor availability at the cutter position	0: forbidden 1: in use	1	
241.0	Functional selections	0: Bar-tacking 5: Pattern bar-tacking 7: Button sewing	0	
245.--	Clear false alarm to add lubricating oil	Pre R key.	The screen displays the total number of stitches.	
268.--	Password management	0. LoCk: lock with password 1. UkCH: mechanic password check 2. UkMo: mechanic password modification 3. UkCL: mechanic password	0. LoCk	Enter the submenu for more detailed information

No.	Definition	Adjustment Range	Initial Value	Remarks
		recovery 4. kkCH: key password check 5. kkMo: key password modification 6. kkCL: key password recovery		
CP---	System Check Mode			







**Note: the above parameters are for the use of repairers only and user should not change them without caution.**

### 3.3 Restore Default Setting

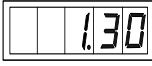
If the user changes some parameters by mistake, which are properly set at delivery, he will use the function of “Recovery to Default Setting” to restore the system.

 **At recovering the default settings, the entire parameters that are set by user before will be recovered. Therefore, please take caution in using this function. For anything unknown, please contact the technicians of the manufacturer, and operate the machine with the instruction from the professionals**

The following is the specific operation step:

- When the Sewing LED is off, operator can press  to have system display , and then the operator needs to press    together. Following the voice from buzzer, the modification of service parameters is started.
- By using the  & , the operator can select the parameter No.67:

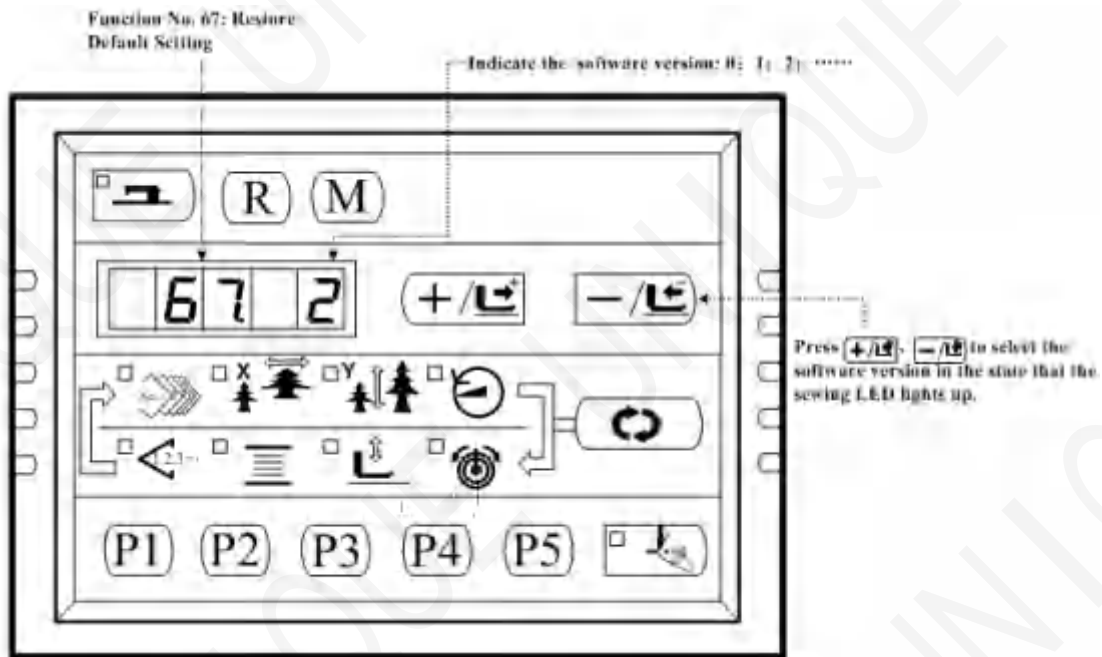

3. Press  $\left[ \frac{\text{LED}}{\text{ON}} \right]$  to turn on the sewing LED, then press  $\left[ \frac{+}{LED} \right]$ ,  $\left[ \frac{-}{LED} \right]$  to select the items needing recovery: 67=0: to restore the panel parameters; 67=25: to restore the machine head board parameters.

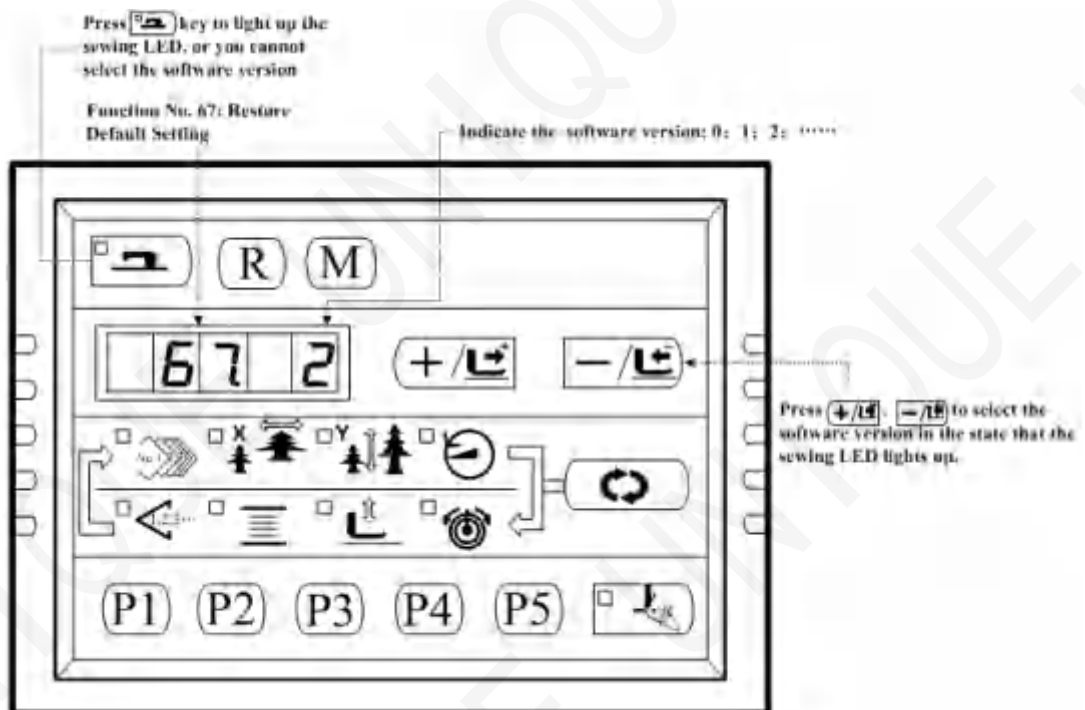

4. After selecting the parameters needed to be restored, press  $\left[ \frac{\text{LED}}{\text{ON}} \right]$  to confirm the software version you want to restore, and when the sewing LED is off, the screen displays "PoFF" (if you select to restore the machine head board parameters, the screen will display "EEP" before "PoFF")

to remind you to shut off the power supply and then turns it on. (Note: if you select unvalid value, there will be no recovery.) Press  to quit the service parameter setting mode and return to normal sewing mode.

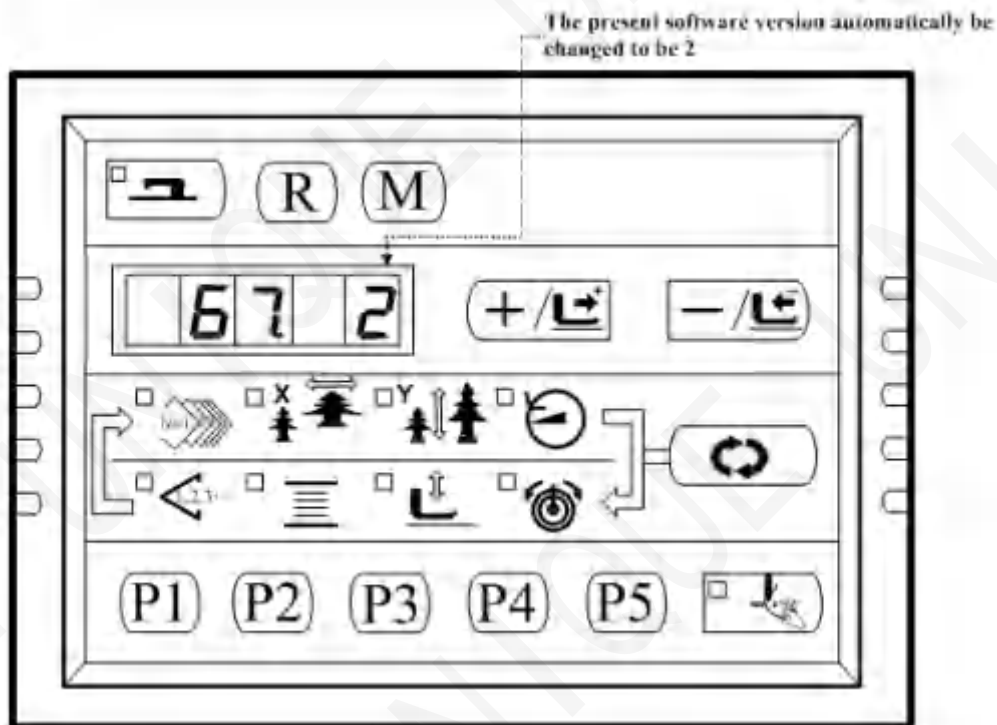

5. When power on, the screen displays “init” indicating parameters are being restored (if you have selected to restore the machine head board parameters, the recovery has been finished and ready for your direct use when the power is on), and after a few seconds the screen will display the sewing interface for pattern No. 1, which means the parameters have been restored and ready for your use.



**Note:** During the restoring process (20 seconds after power on), if the power is cut by accident, the restoring process has to be aborted and you failed to restore the default setting. The software will return to the former state before restoring.

### 3.4 Software Version Display

In the parameter setting mode, use parameter No.65 to enter the next submenu and there are 4 subparameters to indicate the information of the system software version:

When the power is on, initiate the service parameter setting, then press ,  to select parameter No.65 with the screen displaying “65.--”, and then press  to enter the software version display mode when the sewing LED lights up.

- 1.PAnL: to display the software version of control panel
- 2.CtrL: to display the software version of lower computer

3.dSP1: to display the software version of stepping driver DSP1

4.dSP2: to display the software version of stepping driver DSP2

Select the parameter for display. If you need display the software version of control panel, press  to display the detailed information when the screen displays “1. PANL”.

At this time, pattern number LED lights up and displays “-A” (or other letters, due to different software versions) which refers to the manufacturer information. Press  to light up X/Y scale, rotation speed, and thread tension in a cyclic manner to display detailed information of the software version respectively as follows:

Pattern Number LED	X Scale LED	Y Scale LED	Rotation Speed LED	Thread Tension LED
—A	MA201	15	1.	2.
Manufacturer Code	Machine Type	Software Version No.	Software Mother Version No.	Software Daughter Version No.







The above information can be represented comprehensively by MASC201-A-V1.2.15.

The information of different machine types is as follows:

Machine Type Display	Machine Type Information
SC201	III Generation (Open Loop Stepping) SC201 (1900A)
SC203	III Generation (Open Loop Stepping) SC203 (1906A)
AS201	III Generation (Close Loop Stepping) ASC201 (1900A)
AS203	III Generation (Close Loop Stepping) ASC201 (1900A) ASC203 (1906A)
MS201	V Generation (Open Loop Stepping) MSC201 (1900A)
MS203	V Generation (Open Loop Stepping) MSC203 (1906A)
MA201	V Generation (Close Loop Stepping) ASC201 (1900A) MASC201 (1900A)
MA203	V Generation (Close Loop Stepping) ASC201 (1900A) MASC203 (1906A)

Other parameters about the detailed information of software version shall be explained in the same way as described above.

### 3.5 Check Total Number of Stitches and Clear Lubrication Alarm



After the machine runs for a period of time, there may appear E221 “Add Lubricating Oil Alarm” which means you should add lubricating oil. Under this circumstance, initiate service parameter setting after power on, then press ,  to change the screen display to “245.--”, and then press  to display the total number of stitches when sewing LED lights up. Press  to display respectively the number with the counting unit of “ten thousand stitches” on the pattern number LED segment and that of “one stitch” on counter LED segment. The total number of stitches equals to 10000 \*(number of “ten thousand stitches”) + number of “one stitch”. After adding the lubricating oil, press  to clear the total number of stitches and then the machine can continue to work normally. (Note: if you just want to check the total number of stitches and clear not, press  to return to parameter setting mode.)

## 4. Lockstitch Button Sewing Function

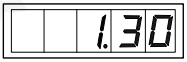
### 4.1 Lockstitch Button Sewing Function Setting

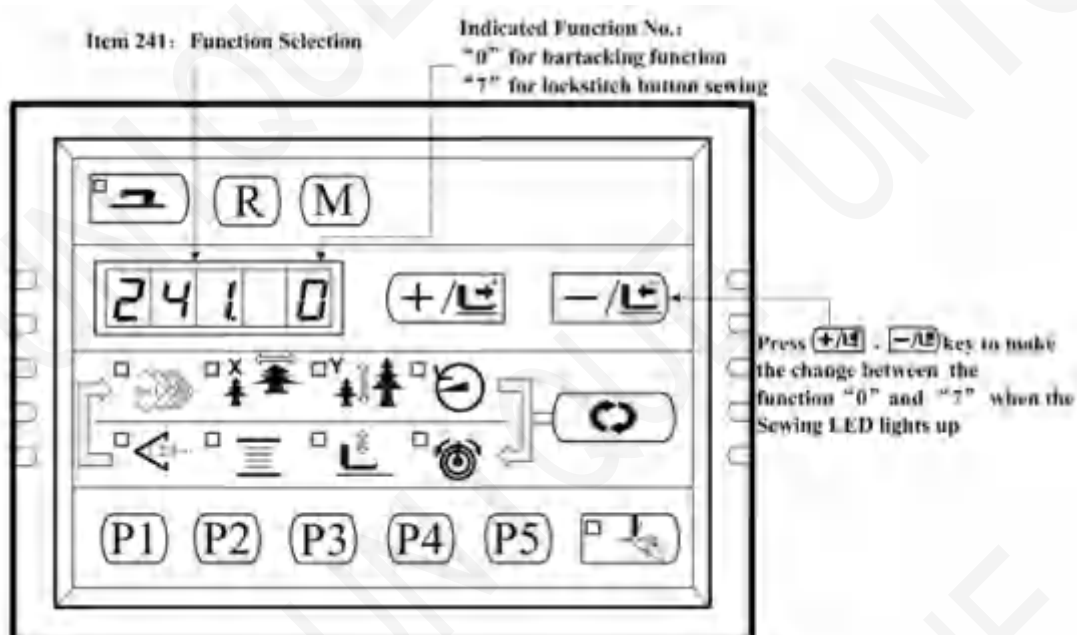
- 1、 Press **(M)** key, while the Sewing LED is not illuminated, and then the Panel display . Press **(P1)** **(P3)** **(P5)** simultaneously, you would hear the ring of the buzzer, and then you are able to adjust the setting.
- 2、 Press **(+/-<sup>+</sup>)**、 **(-/-<sup>-</sup>)** key to select No.241:



- 3、 Press  key to light up the sewing LED, and then press **(+/-<sup>+</sup>)** or **(-/-<sup>-</sup>)** key to change the Function NO. to "7". Press  key again to save the setting and the Sewing LED goes off.
- 4、 Press **(M)** key to exit and Power off. Power on, and the machine has changed to be a lockstitch button sewing machine.

**Attention: The lockstitch button sewing function need particular Presser, for details, please contact your machine agent.**

## 5. Update the Pattern Data by USB Flash

### 5.1 Pattern Data Update

Support import (addition) of single VDT pattern:









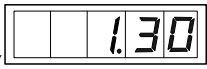

62=1: import (add) pattern, and cover the pattern of the same number with imported pattern;

62=2: export all extrapolation patterns to USB storage device;

62=3: clear (format) the panel's storage area for extrapolation patterns;

#### Pattern Data Update Operations:

User can import VDT format patterns to the control system via U disk, with the updated pattern number from 101 to 200. User can also export existing patterns numbered 101~200 that are stored in the control system to U disk. (Note: V Generation computerized control system doesn't support BIN format patterns.)

1. Use pattern-making software to make pattern file in VDT format and name it by "XXX.VDT". (Note: XXX shall be a number between 101~200 which at the same time is the updated pattern number.)
2. Create a new file folder named DH under the root directory of U disk, and save the pattern made in the previous step under the directory of DH (many patterns at one time).
3. When the sewing LED is off, press  to have the screen display , and then press    together. Following the voice from the buzzer, the modification of service parameters is started.
4. Press ,  to select parameter No. 62 and connect the U disk where patterns are stored to the USB interface at the right side of the panel.
5. Press , then press ,  to change the function number to "1" when the sewing LED lights up, and then press  to confirm the function number.



**Note: before this operation, please confirm the U disk having been connected to USB interface; if not, this update operation cannot be done and the panel will hint error E512 "USB storage device not found".**

6. When the panel displays "USB——", it means the pattern data update operation is being conducted. After the update is finished, the panel will automatically shift to parameter interface and the screen will display "62.0" which indicates the completion of pattern data update.
7. After the update is finished, the patterns numbered 101~200 that have already been stored in the system before the update will be back-uped under the DH directory of the U disk and renamed in the form of "BAK\_XXX.VDT" (note: XXX is the original pattern number between 101~200).

**Note: if there are already patterns numbered 101~200 in the system, patterns named with different numbers can be added to the system via U disk following the above operations; if the pattern numbers in the U disk are the same with those in the system, the patterns with the same number in the system will be replaced.**

**In addition, apart from the pattern update import operation under function number “1”, user can also change the function number to “2” and “3” to export patterns and delete operations respectively. To change function number to “2” actually equals to manual operation of step 7 to back up patterns, while to change function number to “3” is to delete all patterns numbered 101~200, which may be done in case of error E506 “Extrapolation Pattern Storage Area Full” and error E507 “Extrapolation Pattern Storage Area Format Abnormal”.**

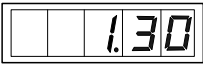
8. Open pattern lock: after update, if the patterns updated via U disk cannot be selected on the sewing interface, the possible reason is that the pattern lock is unopened, for the default setting of patterns number 101~200 is locked and unable to be selected. User need make the following operation:

9. Press  to have the screen display , and then press ,  to select parameter No. 201.

用户参数列表中的“201”号参数：  
设定是否可以读出图案数据

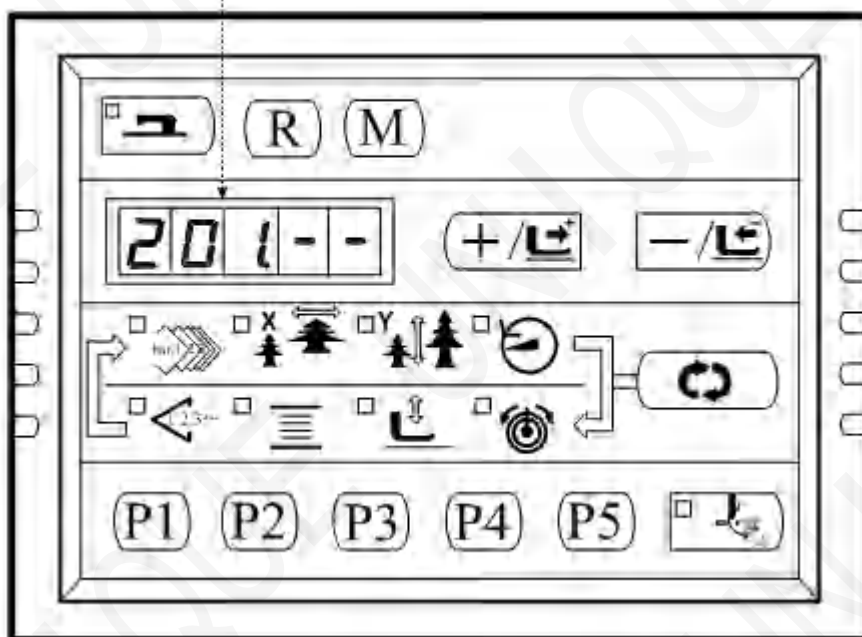

10. Press  to enter pattern switching mode when the sewing LED lights up, and the screen displays “1-1”:

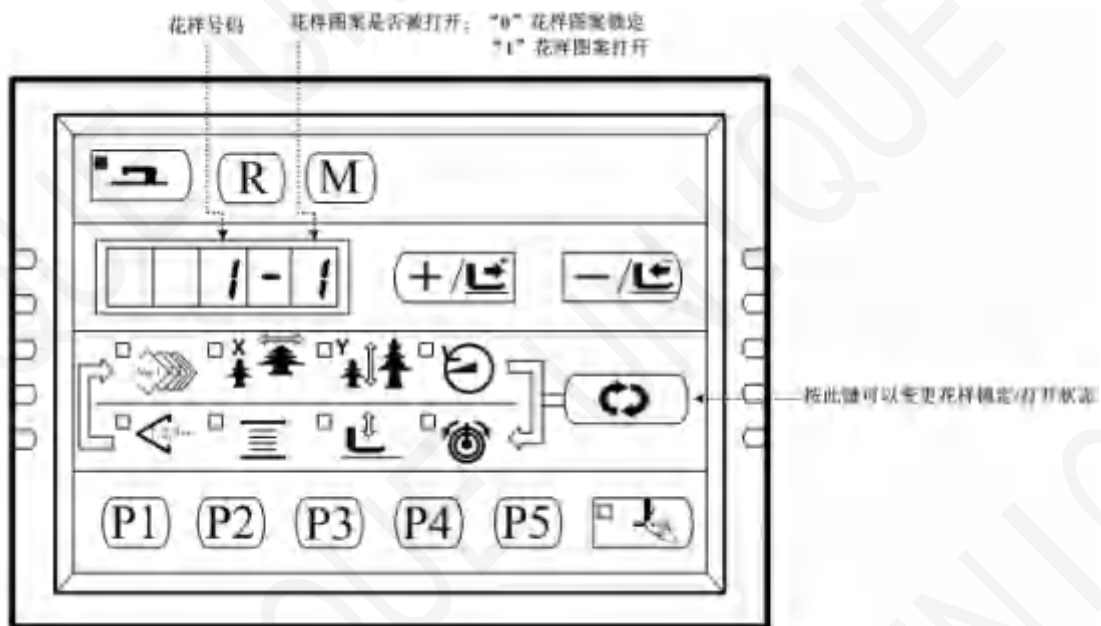

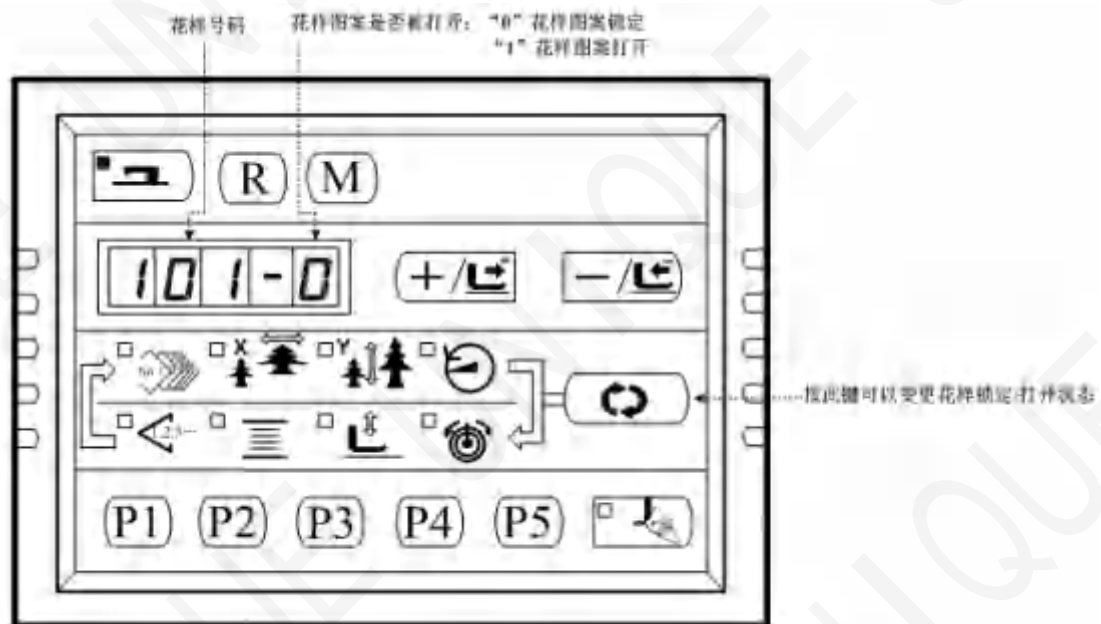

11. Press to select the pattern number needed (such as pattern No. 101):





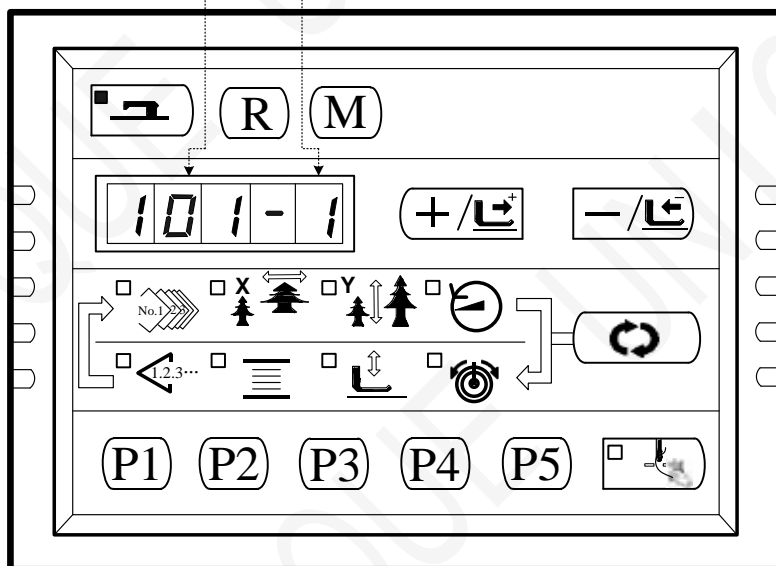

12. Press to change "101-0" to "101-1", that is, to unlock pattern No. 101:

花样号码 提示花样图案被打开













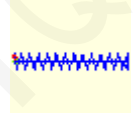



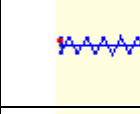
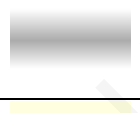
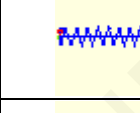

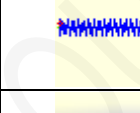

13. Press  to save the set parameter and return to the interface of step 11 when the sewing LED is off; user can repeat the operations of steps 11-12, to lock or unlock all the patterns needed.

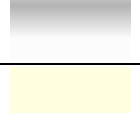

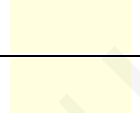

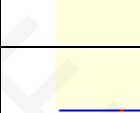





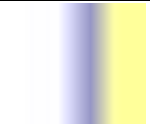
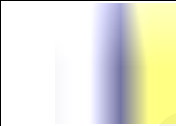
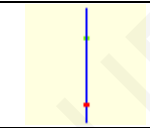
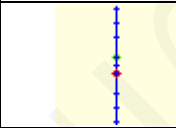
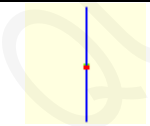
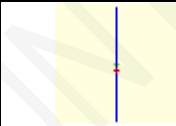

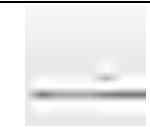

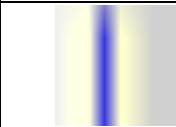
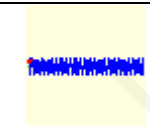

14. Press  to return to normal sewing mode.

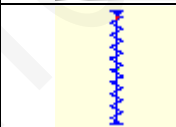
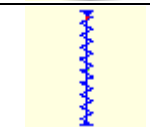
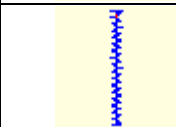
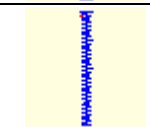





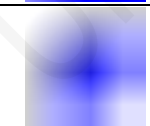



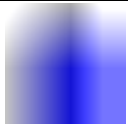

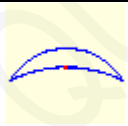
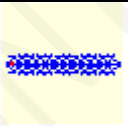
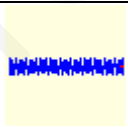
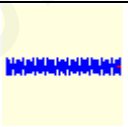
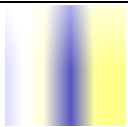
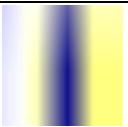

15. Use  to select pattern number icon (refer to [2.4.1 Item Data Setting]), and then press ,  to check the unlocked pattern No. 101 and start sewing.

## 6 Appendix 1

### 6.1 List of Patterns in 1900A Controller

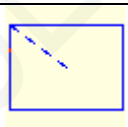
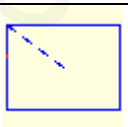
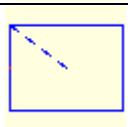
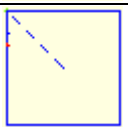
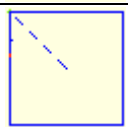
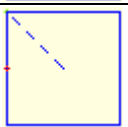
NO.	Patterns	Stitch Number	Length × Width (mm)	NO.	Pattern	Stitch Number	Length × Width (mm)
1		41	16.1×2	2		41	10.2×2
3		41	16×2.4	4		41	24×3
5		27	10.1×2	6		27	16×2.4
7		35	10.1×2	8		35	16×2.4
9		55	24×3	10		63	24×3
11		20	6.1×2.4	12		27	6.2×2.4
13		35	6.1×2.4	14		14	8×2
15		20	8×2	16		27	8×2
17		20	10×0	18		27	10×0
19		27	25.2×0	20		35	24.8×0
21		40	25.2×0	22		43	35×0
23		27	4×20	24		35	4×20

25		41	4×20	26		55	4×20
27		17	0×20	28		20	0×10
29		20	0×20	30		27	0×20
31		51	10.1×7	32		62	12.1×7
33		23	10.2×6	34		30	12×6
35		47	7×10	36		47	7×10
37		89	24×3	38		27	8×2
39		25	11.8×12	40		45	12×12
41		28	2.4×20	42		38	2.4×25
43		38	2.4×25	44		57	2.4×30
45		75	2.4×30	46		41	2.4×30
47		89	8×8	48		98	8×8
49		147	8×8	50		163	8×8
51		110	7.9×7.9	52		120	7.9×7.9

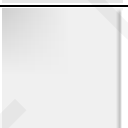
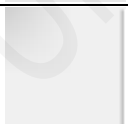
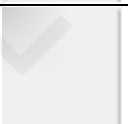
53		130	7.9×7.9	54		51	12.4×10.2
55		50	12.4×10.2	56		52	21×6
57		57	21×6	58		102	19×3
59		115	40×5	60		115	40×5
61		93	5×30	62		109	5×30
63		108	40×30	64		80	40×30
65		64	40×30	66		96	30×30
67		76	30×30	68		60	30×30
69		52	40×30	70		40	40×30
71		32	40×30	72		44	30×30
73		36	30×30	74		28	30×30
75		60	40×30	76		48	40×30
77		36	40×30	78		56	30×30
79		44	30×30	80		36	30×30

81		67	40×30	82		51	40×30
83		39	40×30	84		55	30×30
85		35	30×30	86		42	30×30
87		32	30.1×30	88		26	30×30
89		74	20×24	90		54	20×24
91		65	20×20	92		49	20×20
93		39	20×20	94		63	25×20
95		51	25×20	96		45	25×20
97		42	25×20	98		33	25×20
99		27	25×20	100		88	30×25











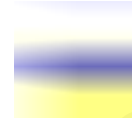
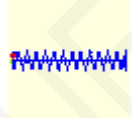
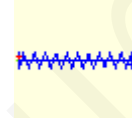

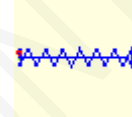

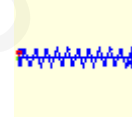

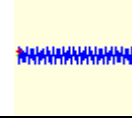
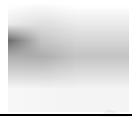

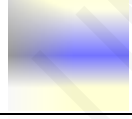
## 6.2 List of Patterns for Button-sewing in 1900B Controller

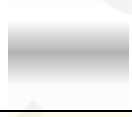

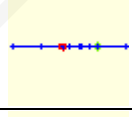

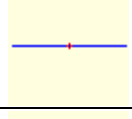
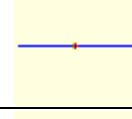
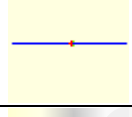
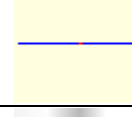

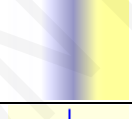
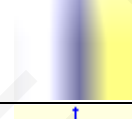



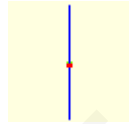
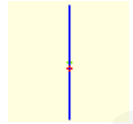

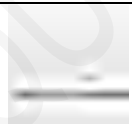
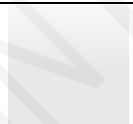
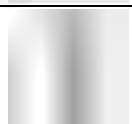
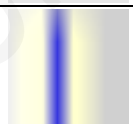
No.	Pattern	Thread Number	Standard Sewing Length X(mm)	Standard Sewing Length Y(mm)	No.	Pattern	Thread Number	Standard Sewing Length X(mm)	Standard Sewing Length Y(mm)
1 34		6-6	3.4	3.4	18 44		6	3.4	0
2 35		8-8			19 45		8		
3		10-10			20		10		

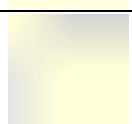

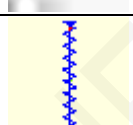
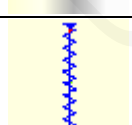
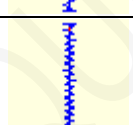
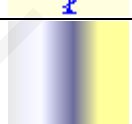
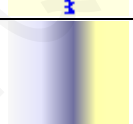
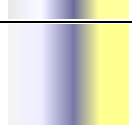
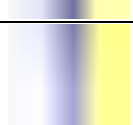
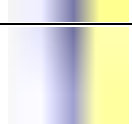
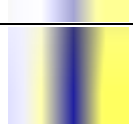

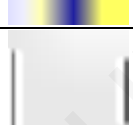















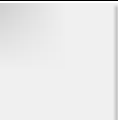
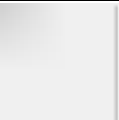

No.	Pattern	Thread Number	Standard Sewing Length X(mm)	Standard Sewing Length Y(mm)	No.	Pattern	Thread Number	Standard Sewing Length X(mm)	Standard Sewing Length Y(mm)
4		12-12			21		12		
5 36		6-6			22		16		
6 37		8-8			23 46		6	0	3.4
7		10-10			24		10		
8		12-12			25		12		
9 38		6-6			26 47		6-6	3.4	3.4
10 39		8-8			27		10-10		
11		10-10			28 48		6-6		
12 40		6-6			29		10-10		
13 41		8-8			30 49		5-5-5	3.0	2.5
14		10-10			31		8-8-8		
15 42		6-6			32 50		5-5-5		
16 43		8-8			33		8-8-8		
17		10-10							

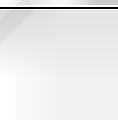
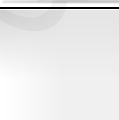





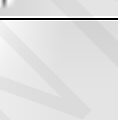
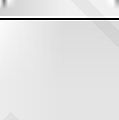
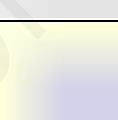



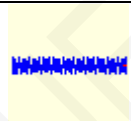
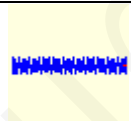

### 6.3 List of Patterns for Doubling Controller

NO.	Patterns	Stitch Number	Length × Width (mm)	NO.	Patterns	Stitch Number	Length × Width (mm)

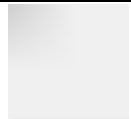
1		41	16.1×2	2		41	10.2×2
3		41	16×2.4	4		41	24×3
5		27	10.1×2	6		27	16×2.4
7		35	10.1×2	8		35	16×2.4
9		55	24×3	10		63	24×3
11		20	6.1×2.4	12		27	6.2×2.4
13		35	6.1×2.4	14		14	8×2
15		20	8×2	16		27	8×2
17		20	10×0	18		27	10×0
19		27	25.2×0	20		35	24.8×0
21		40	25.2×0	22		43	35×0
23		27	4×20	24		35	4×20
25		41	4×20	26		55	4×20
27		17	0×20	28		20	0×10

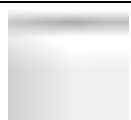
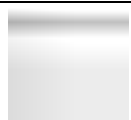
29		20	0×20	30		27	0×20
31		51	10.1×7	32		62	12.1×7
33		23	10.2×6	34		30	12×6
35		47	7×10	36		47	7×10
37		89	24×3	38		27	8×2
39		25	11.8×12	40		45	12×12
41		28	2.4×20	42		38	2.4×25
43		38	2.4×25	44		57	2.4×30
45		141	10×30	46		122	10×30
47		97	10×30	48		109	10.1×30
49		122	10.1×30	50		265	10×30
51		108	40×30	52		80	40×30
53		64	40×30	54		96	30×30
55		76	30×30	56		60	30×30

57		52	40×30	58		40	40×30
59		32	40×30	60		44	30×30
61		36	30×30	62		28	30×30
63		60	40×30	64		48	40×30
65		36	40×30	66		56	30×30
67		44	30×30	68		36	30×30
69		67	40×30	70		51	40×30
71		39	40×30	72		55	30×30
73		43	30×30	74		35	30×30
75		42	30×30	76		32	30.1×30
77		26	30×30	78		103	30×25
79		82	30×25	80		64	30×25
81		80	20×30	82		60	20×30
83		80	30×20	84		60	30×20

85		74	20×24	86		54	20×24
87		115	40×5	88		115	40×5
89		93	5×30	90		109	5×30
91		65	20×20	92		49	20×20
93		39	20×20	94		63	25×20
95		51	25×20	96		45	25×20
97		42	25×20	98		33	25×20
99		111	60×40	100		91	60×40

#### 6.4 Error List

Display	Error Name	Content of Error	Solution
E7	Machine Lock Error	The main-shaft of sewing machine can't rotate due to some problem.	Turn off power and release the trouble
E10	Pattern NO. Error	The prepared pattern number is not registered in ROM or it is set at unreadable. The pattern is 0.	Press RESET switch to confirm the pattern NO. Confirm the content in memory switch No.201.
E30	Needle Bar Up Position Error	The needle bar is not at UP position.	Turn the hand pulley to return the needle bar to its UP position.
E40	Sewing Area Over	The sewing area is over the limit.	Press RESET switch to confirm the X/Y scale rate
E43	Enlargement Error	The sewing stitch is below 10mm.	Press RESET switch and confirm the pattern and X/Y scale rate.

E50	Pause	Press the RESET switch while sewing machine is running. The machine pauses.	Restart or return-to-origin after pressing RESET switch for thread-trimming
E221	Abnormal alarm to add lubricating oil	It is time to add lubricating oil to certain parts of the machine, so the machine stops working.	Restart the machine, enter parameter No. 245 and press RESET key, and then power on again
E302	Head Tilt Error	Head tilt detection switch is turned ON.	The sewing machine cannot be operated with the head tilted. Return the sewing machine head to its proper position
E303	24V Power Supply Error	24V voltage is below level.	Turn off the power, and after a while power on again.
E305	Presser Position Error	Presser is not at proper position.	Turn off the power and check connection of the CZ025 at the head signal circuit board. If the connection is ok, check the optocoupler.
E306	Thread-catching position error	The thread-catching device is at wrong position.	Turn off the power and check the connection of the CZ026 at the head signal circuit board. If the connection is ok, check the optocoupler.
E307	Cutter Position Error	The cutter is not at the right position.	Turn off the power and check the connection of the CZ024 at the head signal circuit board. If the connection is ok, check the optocoupler.
E500	Pattern parameter unavailable on the control panel	The control panel cannot read the pattern parameter from EEPROM.	
E501	Control panel memory parameter range abnormal	The control panel cannot read the memory parameter from EEPROM.	Press RESET key to enter parameter No. 67 and restore the default setting
E502	Lower computer parameter abnormal	The machine head board parameter received by control panel from the lower computer is abnormal.	Press RESET key to enter parameter No. 67 and restore the default setting
E503	Abnormal Pattern Parameter of the Control Panel	Pattern parameter doesn't exist when used by the control panel.	
E504	Abnormal Pattern Parameter Range of the Control Panel	Pattern parameter range is abnormal when used by the control panel.	Press RESET key to enter parameter No. 67 and restore the default setting

E505	Abnormal Pattern Format of the Control Panel	Pattern format is abnormal when the control panel reads pattern sewing data	Select other patterns
E506	The Storage Space for Extrapolation Patterns Full	When patterns are imported to the control panel via USB, the storage space for such patterns is found full.	Use parameter No. 62 to export patterns stored and format the storage area. Then try to import patterns again.
E507	Extrapolation Pattern Pormat Abnormal	Pattern data is found abnormal when its format data is read by the control panel	Use parameter No. 62 to format the storage area
E508	Patterns imported via USB already exist	Patterns with same numbers are found when patterns are imported via USB	Change the pattern number of the patterns to be imported
E509	USB Patterns Not Found	The pattern number to be imported can not be found after USB connection	Import the existing patterns first
E510	Extrapolation patterns delete error	The pattern number to be deleted can not be found	Delete the existing patterns first
E511	Extrapolation patterns read error	The pattern data is abnormal when read by the control panel	Select other patterns
E512	USB storage device error	It is abnormal to read the USB storage device in case of pattern import and export.	Change the USB storage device
E513	Machine type parameter error	The machine type data read by the control head is not within the set range.	Press RESET key to automatically enter parameter No. 241 to save the machine type
E515	Main control firmware program check error	The firmware file fails the check before program update via USB	Check whether firmware program file "mControl" is under the "update" directory of the U disk
E516	Main control firmware program update failure	Update failure is caused by error occurring during the main control firmware program update	Check the update file and update again
E517	Panel firmware program not found	The update file is not found in the U disk when update	Check whether firmware program file "Kdpanel" is under the "update" directory of the U disk
E518	Panel firmware program check error	The firmware file fails the check before program update via USB	Check whether firmware program file "Kdpanel" is under the "update" directory of the U disk and whether the file is valid

E519	Panel firmware program update failure	Update failure is caused by error occurring during the panel firmware program update	Check the update file and update again
E600	Pedal not in the middle position	Pedal is depressed when entering the ready sewing status	Make sure the pedal is not depressed when entering the ready sewing status
E601	Air valve (fan) problem	After start, the system detects abnormal signal about the voltage of the air valve or fan	Shut down the machine to check if there is any short circuit
E602	Motor running abnormal	When the main shaft motor is running, the range of the electrical angle is abnormal at 0°	Shut down the machine to check the motor encoder
E603	Emergency stop switch not at normal position	Before start the emergency stop switch is found pressed down	Manually solve the problem
E604	Machine stop due to aging	In aging mode, the machine stops.	Shut down the machine
E680	Stepping Close Loop DSP1(X25/X27) Communication Error	The verification of the received order at stepping board is failed	Check the connection of SPI communication cable
E681	Stepping Close Loop DSP1 1 <sup>st</sup> Route (X27) Over-Current	Large current is detected by hardware	At first, please check motor. Then check the resistance and sensor value. If the motor is ok, user should check the hardware on stepping board
E682	Stepping Close Loop DSP1 1st Route (X27) Position Error	The detected encoder response position is not same to the position set in order	Change the stepping motor to open loop mode and run it. If the motor can work normally, the motor should be ok. If the motor can not work normally, user should check the driving part on the stepping board and the motor itself. After the above works, user should check the encoder. Make sure the connection and the condition of the encoder cable is ok. And make sure the signal response part on the stepping board and the encoder itself is ok.

E683	Stepping Close Loop DSP11st Route (X27)Over-speed	The system will give this warning when it detects the abnormal motor speed via the encoder response signal	The checking method is same to that in Position Error
E685	Stepping Close Loop DSP12nd Route (X25) Over-Current	Large current is detected by hardware	At first, please check motor. Then check the resistance and sensor value. If the motor is ok, user should check the hardware on stepping board
E686	Stepping Close Loop DSP12nd Route (X25) Position Error	The detected encoder response position is not same to the position set tin order	Change the stepping motor to open loop mode and run it. If the motor can work normally, the motor should be ok. If the motor can not work normally, user should check the driving part on the stepping board and the motor itself. After the above works, user should check the encoder. Make sure the connection and the condition of the encoder cable is ok. And make sure the signal response part on the stepping board and the encoder itself is ok.
E687	Stepping Close Loop DSP12nd Route (X25) Over- speed	The system will give this warning when it detects the abnormal motor speed via the encoder response signal	The checking method is same to that in Position Error
E690	Stepping Close Loop DSP2(X21/X23) Communication Error	The verification of the received order at stepping board is failed	Check the connection of SPI communication cable
E691	Stepping Close Loop DSP21st Route (X23) Over-Current	Large current is detected by hardware	At first, please check motor. Then check the resistance and sensor value. If the motor is ok, user should check the hardware on stepping board

E692	Stepping Close Loop DSP21st Route (X23) Position Error	The detected encoder response position is not same to the position set tin order	Change the stepping motor to open loop mode and run it. If the motor can work normally, the motor should be ok. If the motor can not work normally, user should check the driving part on the stepping board and the motor itself. After the above works, user should check the encoder. Make sure the connection and the condition of the encoder cable is ok. And make sure the signal response part on the stepping board and the encoder itself is ok.
E693	Stepping Close Loop DSP21st Route (X23) Over- speed	The system will give this warning when it detects the abnormal motor speed via the encoder response signal	The checking method is same to that in Position Error
E695	Stepping Close Loop DSP22nd Route (X21)Over-current	Large current is detected by hardware	At first, please check motor. Then check the resistance and sensor value. If the motor is ok, user should check the hardware on stepping board
E696	Stepping Close Loop DSP2 2nd Route (X21) Position Error	The detected encoder response position is not same to the position set tin order	Change the stepping motor to open loop mode and run it. If the motor can work normally, the motor should be ok. If the motor can not work normally, user should check the driving part on the stepping board and the motor itself. After the above works, user should check the encoder. Make sure the connection and the condition of the encoder cable is ok. And make sure the signal response part on the stepping board and the encoder itself is ok.
E697	Stepping Close Loop DSP2 2nd Route (X21) Over- speed	The system will give this warning when it detects the abnormal motor speed via the encoder response signal	The checking method is same to that in Position Error
E730	Encoder error	The Encoder of main-shaft Motor is no signal	Check the cable of main-shaft motor
E733	MainShaft Over-current	Motor stop	If there is no machenic problem, then check the connection of the main shaft encoder

E735	Current abnormal when stop	Over-current occurs during the stop process of the main shaft	Turn off the power and repower the machine after a while. Change the main shaft motor if the motor is damaged; if problem remains, change the main board.
E736	Main board IPM sudden over-current	The current for the main board IPM drive module is too much within a short period of time	Turn off the power and repower the machine after a while. Change the main shaft motor if the motor is damaged; if problem remains, change the main board.
E737	Main board IPM multiple over-current	Over-current happens repeatedly to the main board IPM drive module after power on	Turn off the power and repower the machine after a while. Change the main shaft motor if the motor is damaged; if problem remains, change the main board.
E740	Main Shaft Over-speed	The system detects the actual speed of the main shaft motor exceeding the speed limit	Turn off the power and repower the machine after a while.
E 811	Overvoltage Error	The voltage of power is over the specified value.	Confirm the voltage of power
E 813	Low Voltage Error	The voltage of power is too low.	Confirm the voltage of power.
E 901	Main shaft driver abnormal	The error is detected in main shaft driver.	Turn off the power and repower the machine after a while.
E 902	Stepping board 90V power supply error	Stepping board 90V short circuit,	Turn off the power supply and then turn it on again after a while.
E 903	Stepping driver Error	Over-current occurs to stepping drive board.	Turn off the power and repower the machine after a while.
E 904	24V power supply error,	24V over-current	Turn off the power supply and then turn it on again after a while.
E 907	X Origin Search Error	X origin sensor doesn't change.	Turn off power and check the connections of CZ021 on head signal circuit board and X9 on control box.
E 908	Y Origin Search Error	Y origin sensor doesn't change.	Turn off power and check the connections of CZ022 on head signal circuit board and X9 on control box.
E909	Thread-trimming Motor Origin Search Error	Thread-trimming origin sensor doesn't change.	Turn off power and check the connections of CZ022 on head signal circuit board and X9 on control box.
E 910	Presser Origin Search Error	Presser origin sensor doesn't change.	Turn off power and check the connections of CZ025 on head signal circuit board and X9 on control box.

E 913	Thread-catching Origin Search Error	Thread-catching origin sensor doesn't change.	Turn off power and check the connections of CZ026 on head signal circuit board and X9 on control box.
E 916	Communication Error between Main-board and Stepping Board	Communication between Main-board and Stepping Board is down.	Turn off the power and repower the machine after a while. Check the connections of the communication cable, main board and drive board.
E920	Stepping Software Version Error	The software versin for the stepping board is false.	Change the stepping board or update the stepping board program.
E943	Machine Head Board Parameter Abnormal with Lower Computer	The lower computer read abnormal parameter from the machine head board.	Check the machine head board and the connection of X9 cable. Press RESET key to use parameter No. 67 to restore the parameters of the machine head board.
E946	Control Panel Circuit Board EEPROM Read and Write Error	Control panel circuit board can not read and write EEPROM.	Turn off the power and repower the machine after a while.
E999	Undefined Error	The control panel can not identify the error code sent by the lower computer.	Shut down the machine and update the control panel program.

## 7 Appendix 2

### 7.1 Installation Size of Control Box

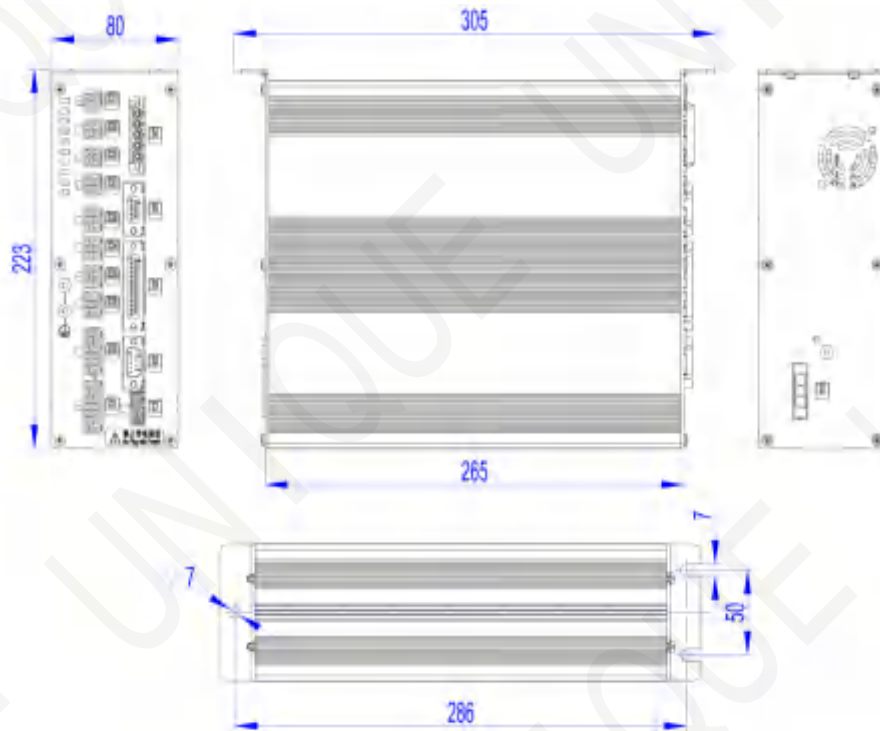

### 7.2 Installation Size of Operation Box

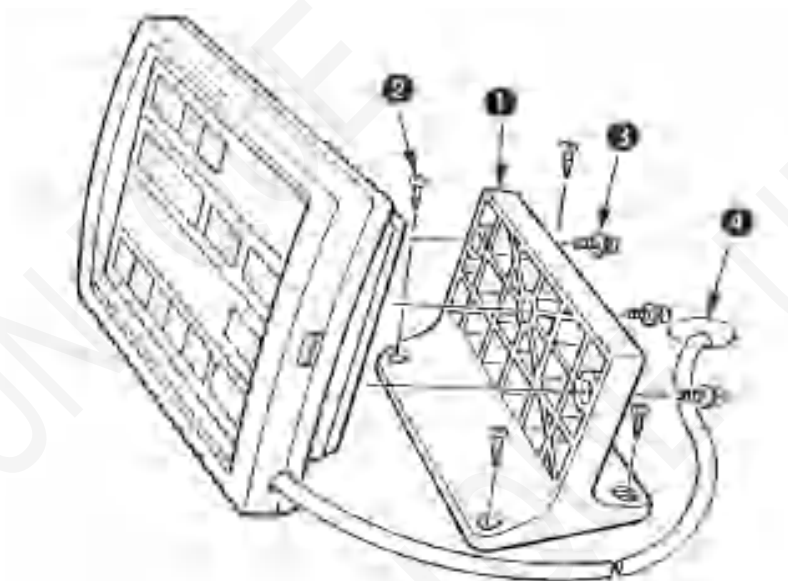

### 7.3 Diagram of Connection of the External Cable and Control Box

#### 1、MSC201 Control Box Back Wiring Interface Diagram

Note: the external cables bear corresponding serial number, and please check carefully before connection (refer to diagram No. 5).

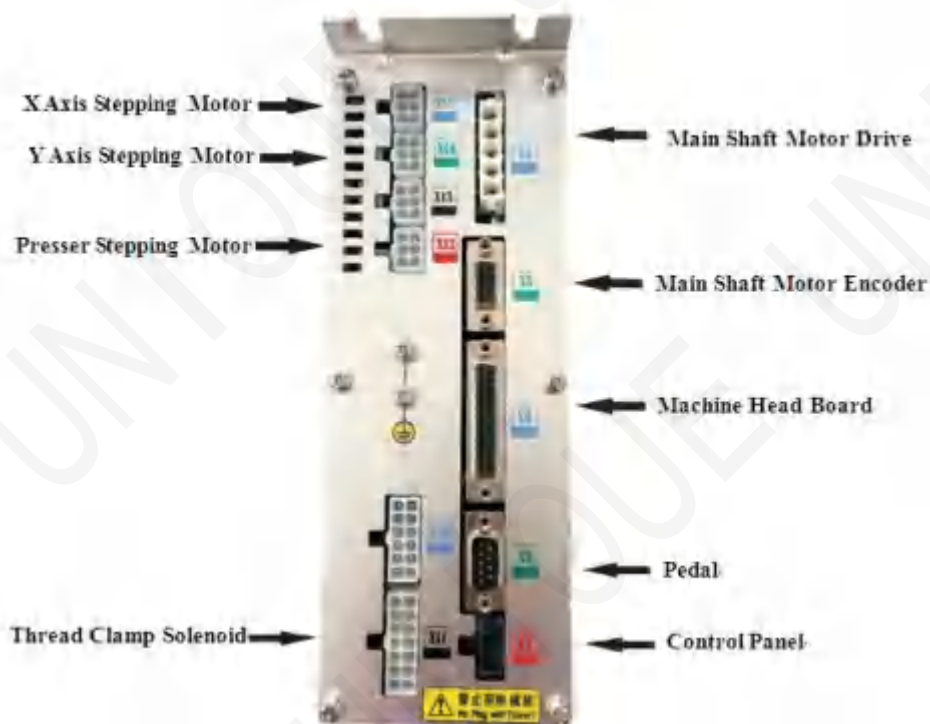

## 2、 MASC201Control Box Back Wiring Interface Diagram

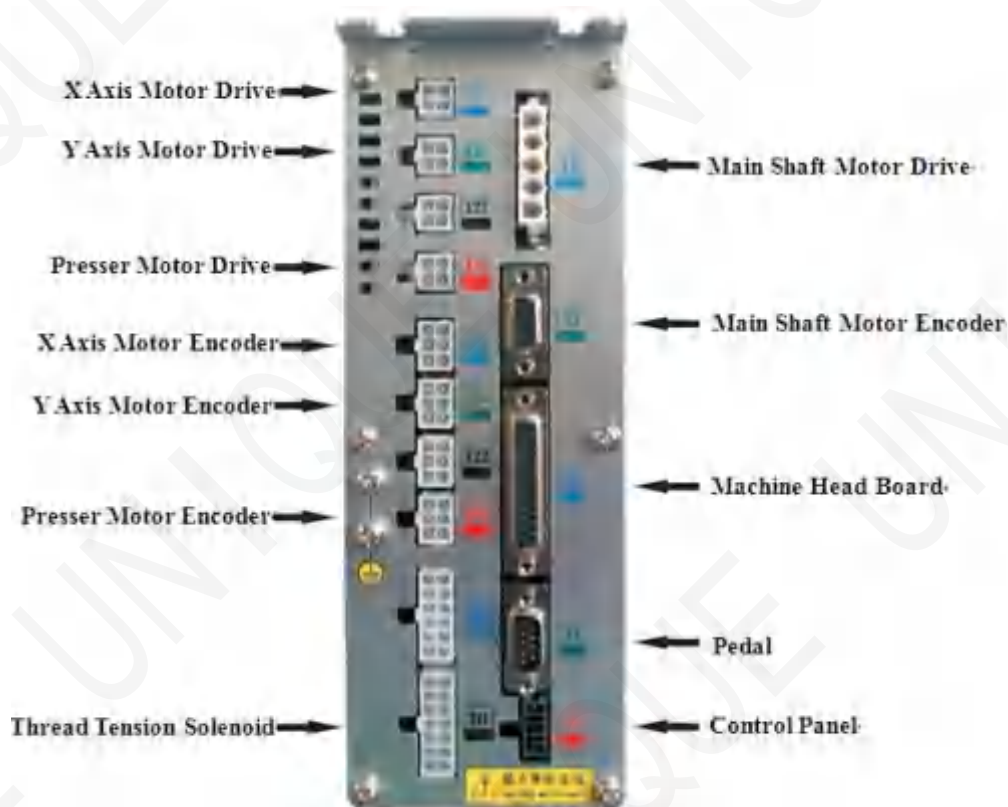

### 7.4 The Control System Diagram

#### 1、MSC201-2D-A

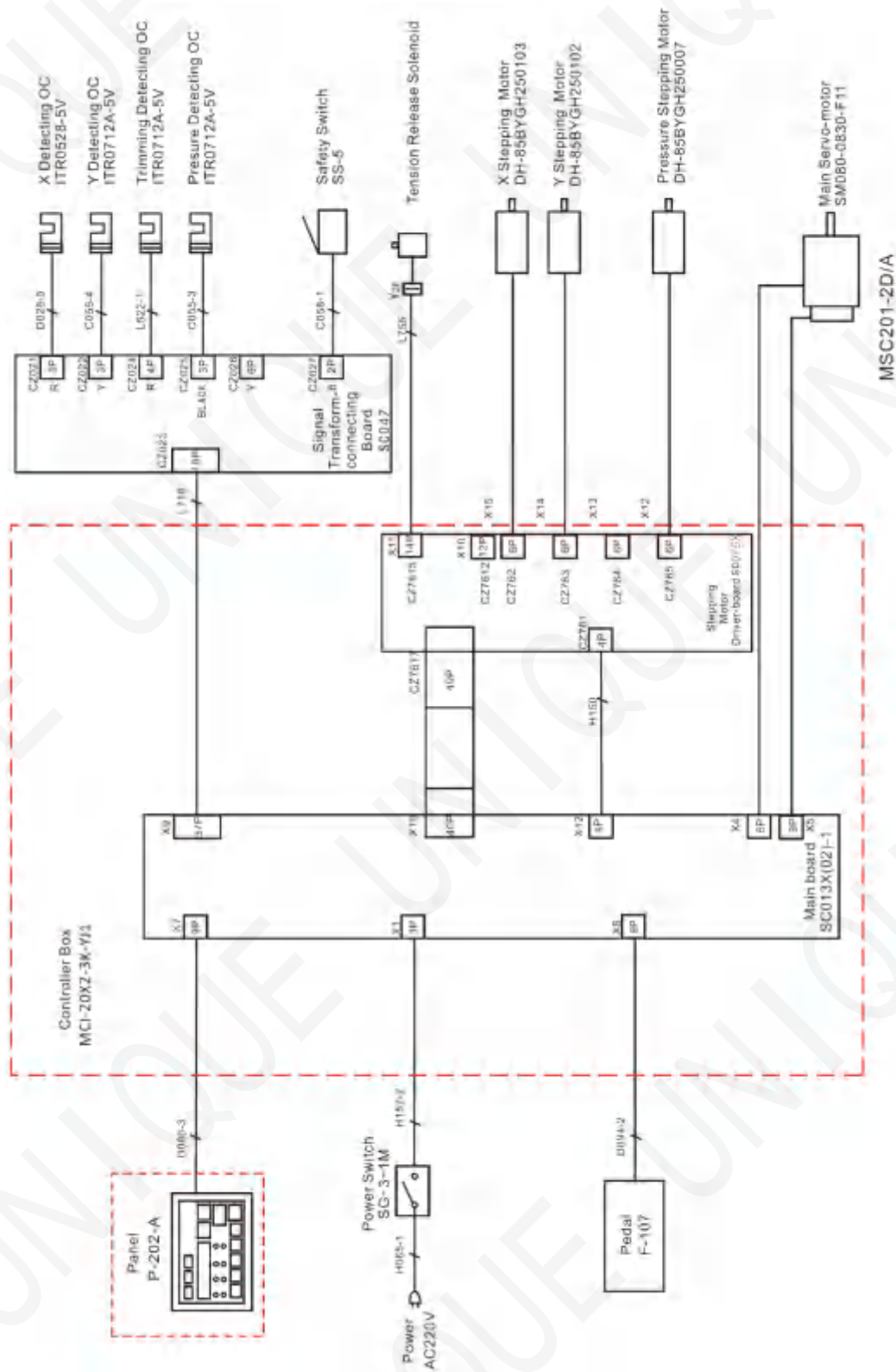

2、MASC201-2D-A

