













UN868-221226

Computerized double needle compound feed post bed lockstitch sewing machine



Product features

- The powerful compound feeding system including feed dog feeding, needle feeding and alternating presser foot feeding, guarantees feeding material freely without shift.
- The lifting height of presser foot can reach 20mm which is convenient to sew heavy materials.
- Max. alternation of presser foot reach 9mm which can sew differential thick materials.
- Large working space (335mm width and 295mm height) which would be easier for large area materials.
- Efficient basic functions such as automatic thread trimmer, automatic back reverse and pneumatic presser foot lifter.

						
UN868-221226	DPX35 90-180	0-12 (mm)	0-20 (mm)	LED	4.0-6.0 (bar)	2500 (rpm)
						
lockstitch	335x295 (mm)	200-240V,50/60HZ	750W	745x370x875 mm	82/76 kg	



Code diagram

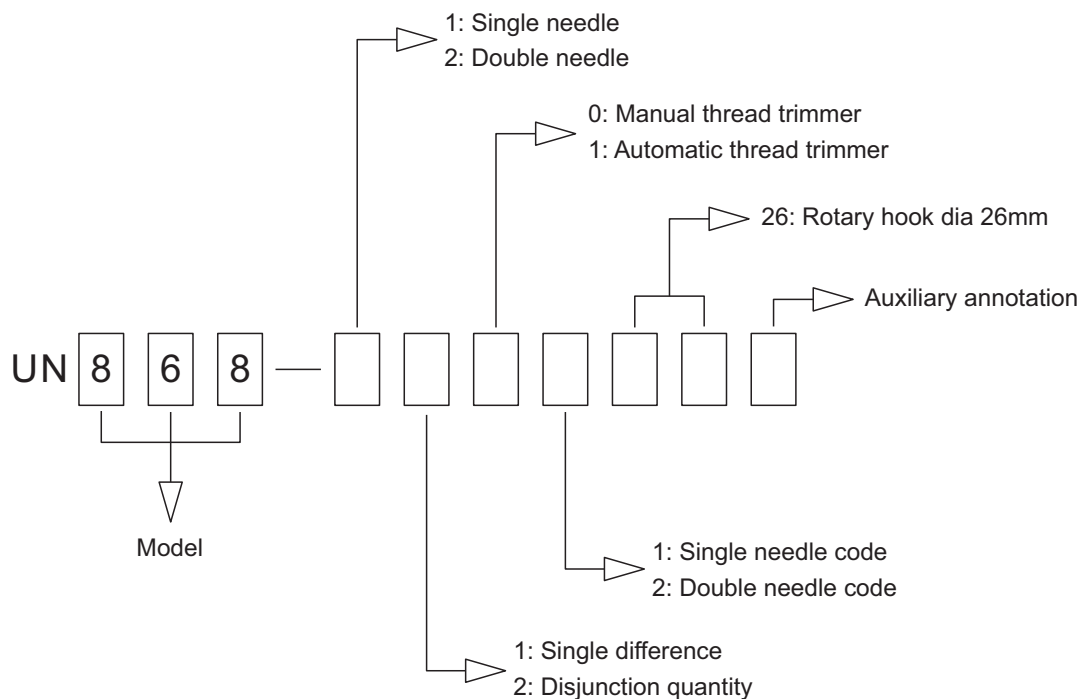

Function



Bottom feed, needle feed and alternating presser foot feeding



Single needle

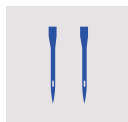

Double needle (6/8/10/12mm)



Automatic thread trimmer

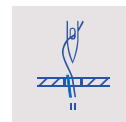

Manual thread trimmer



Single needle code

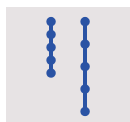

Double needle code

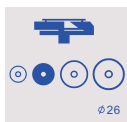

Rotary hook dia 26mm



Automatic back reverse



Manual back reverse



Auto foot lifter



Quick stroke adjustment

